

Complex Analysis

Christian Berg

2016

Department of Mathematical Sciences
Universitetsparken 5
2100 København Ø
© Department of Mathematical Sciences 2016

Preface

The present notes in complex function theory is an English translation of the notes I have been using for a number of years at the basic course about holomorphic functions at the University of Copenhagen.

I have used the opportunity to revise the material at various points and I have added a 9th section about the Riemann sphere and Möbius transformations.

Most of the figures have been carried out using the package spline.sty written by my colleague Anders Thorup. I use this opportunity to thank him for valuable help during the years.

Copenhagen, January 2007

Copenhagen, January 2009

In the 2009 edition I have made a small change in section 1.4 and I have corrected some misprints.

Copenhagen, July 2012

In the 2012 edition I have made a small change in Rouché's Theorem and I have corrected some misprints.

Copenhagen July 2013

In the 2013 edition I have made some minor changes in the proofs of Theorem 4.8, Theorem 7.3 and Theorem 8.5.

Copenhagen March 2014

In the 2014 edition I have made some minor changes in Theorems 6.9,6.21 and 8.3.

Christian Berg

Complex Analysis

Preface

§i.	Introduction	
	i.1. Preliminaries	i.1
	i.2. Short description of the content	i.3
§1.	Holomorphic functions	
	1.1. Simple properties	1.1
	1.2. The geometric meaning of differentiability when $f'(z_0) \neq 0$	1.4
	1.3. The Cauchy-Riemann differential equations	1.6
	1.4. Power series	1.9
	1.5. The exponential and trigonometric functions	1.13
	1.6. Hyperbolic functions	1.18
	Exercises for §1	1.20
§2.	Contour integrals and primitives	
	2.1. Integration of functions with complex values	2.1
	2.2. Complex contour integrals	2.2
	2.3. Primitives	2.7
	Exercises for §2	2.12
§3.	The theorems of Cauchy	
	3.1. Cauchy's integral theorem	3.1
	3.2. Cauchy's integral formula	3.7
	Exercises for §3	3.13
§4.	Applications of Cauchy's integral formula	
	4.1. Sequences of functions	4.1
	4.2. Expansion of holomorphic functions in power series	4.6
	4.3. Harmonic functions	4.9
	4.4. Morera's theorem and local uniform convergence	4.10
	4.5. Entire functions. Liouville's theorem	4.15
	4.6. Polynomials	4.16
	Exercises for §4	4.19
§5.	Argument. Logarithm. Powers.	
	5.1. Some topological concepts	5.1
	5.2. Argument function, winding number	5.5

5.3. n 'th roots	5.9
5.4. The logarithm	5.11
5.5. Powers	5.13
5.6. More about winding numbers	5.17
Exercises for §5	5.23
§6. Zeros and isolated singularities	
6.1. Zeros	6.1
6.2. Isolated singularities	6.5
6.3. Rational functions	6.8
6.4. Meromorphic functions	6.11
6.5. Laurent series	6.12
Exercises for §6	6.23
§7. The calculus of residues	
7.1. The residue theorem	7.1
7.2. The principle of argument	7.4
7.3. Calculation of definite integrals	7.8
7.4. Sums of infinite series	7.15
Exercises for §7	7.20
§8. The maximum modulus principle	8.1
Exercises for §8	8.6
§9. Möbius transformations	
9.1. The Riemann sphere and the extended complex plane	9.1
9.2. Möbius transformations	9.4
Exercises for §9	9.10
§A. Appendix	
Various topological results	A.1
Countable and uncountable sets	A.4

List of Symbols

Bibliography

Index



Augustin Louis Cauchy (1789–1857), French

§i. Introduction

i.1. Preliminaries.

In these notes the reader is assumed to have a basic knowledge of the complex numbers, here denoted \mathbb{C} , including the basic algebraic operations with complex numbers as well as the geometric representation of complex numbers in the euclidean plane.

We will therefore without further explanation view a complex number $x + iy \in \mathbb{C}$ as representing a point or a vector (x, y) in \mathbb{R}^2 , and according to our need we shall speak about a complex number or a point in the complex plane. A set of complex numbers can be conceived as a set of points in \mathbb{R}^2 .

Let us recall some basic notions:

A complex number $z = x + iy \in \mathbb{C}$ has a *real part* $x = \operatorname{Re}(z)$ and an *imaginary part* $y = \operatorname{Im}(z)$, and it has an *absolute value* (also called its *modulus*) $r = |z| = \sqrt{x^2 + y^2}$. We recall the important *triangle inequality* for $z, w \in \mathbb{C}$

$$||z| - |w|| \leq |z - w| \leq |z| + |w|.$$

For a non-zero complex number z we denote by $\arg(z)$ the set of its *arguments*, i.e. the set of real numbers θ such that

$$z = r(\cos \theta + i \sin \theta).$$

The pair of numbers (r, θ) for $\theta \in \arg(z)$ are also called *polar coordinates* for the complex number z . More about this will be discussed in Section 5.

Every complex number $z = x + iy$ with $x, y \in \mathbb{R}$ has a complex conjugate number $\bar{z} = x - iy$, and we recall that $|z|^2 = z\bar{z} = x^2 + y^2$.

As distance between two complex numbers z, w we use $d(z, w) = |z - w|$, which equals the euclidean distance in \mathbb{R}^2 , when \mathbb{C} is interpreted as \mathbb{R}^2 . With this distance \mathbb{C} is organized as a metric space, but as already remarked, this is the same as the euclidean plane. The concepts of open, closed and bounded subsets of \mathbb{C} are therefore exactly the same as for the corresponding subsets of \mathbb{R}^2 . In this exposition—with a minor exception in Section 9—formal knowledge of the theory of metric spaces is not needed, but we need basic topological notions from euclidean spaces.

To $a \in \mathbb{C}$ and $r > 0$ is attached the open (circular) disc with centre a and radius $r > 0$, defined as

$$K(a, r) = \{z \in \mathbb{C} \mid |a - z| < r\}.$$

As a practical device we introduce $K'(a, r)$ as the punctured disc

$$K'(a, r) = K(a, r) \setminus \{a\} = \{z \in \mathbb{C} \mid 0 < |a - z| < r\}.$$

A mapping $f : A \rightarrow \mathbb{C}$ defined on a subset $A \subseteq \mathbb{C}$ with complex values is simply called a *complex function* on A . Such a function is called continuous at $z_0 \in A$ if

$$\forall \varepsilon > 0 \exists \delta > 0 \forall z \in A : |z - z_0| < \delta \Rightarrow |f(z) - f(z_0)| < \varepsilon.$$

This definition is completely analogous to continuity of functions with real values. To a complex function $f : A \rightarrow \mathbb{C}$ is attached two real functions $\operatorname{Re} f$, $\operatorname{Im} f$ defined on A by

$$(\operatorname{Re} f)(z) = \operatorname{Re}(f(z)), \quad (\operatorname{Im} f)(z) = \operatorname{Im}(f(z)), \quad z \in A$$

and connected to f by the equation

$$f(z) = \operatorname{Re} f(z) + i \operatorname{Im} f(z), \quad z \in A.$$

We claim that f is continuous at $z_0 \in A$ if and only if $\operatorname{Re} f$ and $\operatorname{Im} f$ are both continuous at z_0 .

This elementary result follows from the basic inequalities for the absolute value

$$|\operatorname{Re} z| \leq |z|, \quad |\operatorname{Im} z| \leq |z|, \quad |z| \leq |\operatorname{Re} z| + |\operatorname{Im} z|, \quad z \in \mathbb{C}.$$

The complex numbers appear when solving equations of second or higher degree. The point of view that an equation of second degree has no solutions if the discriminant is negative, was in the 16'th century slowly replaced by an understanding of performing calculations with square roots of negative numbers. Such numbers appear in the famous work of Cardano called *Ars Magna* from 1545, and it contains formulas for the solutions to equations of the third and fourth degree. Descartes rejected complex roots in his book *La Géométrie* from 1637 and called them imaginary. The mathematicians of the 18'th century began to understand the importance of complex numbers in connection with elementary functions like the trigonometric, the exponential function and logarithms, expressed e.g. in the formulas now known as the formulas of De Moivre and Euler. Around 1800 complex numbers were introduced correctly in several publications, and today Caspar Wessel is recognized as the one having first published a rigorous geometric interpretation of complex numbers. His work: *Om Directionens analytiske Betegning*, was presented at a meeting of The Royal Danish Academy of Sciences and Letters in 1797 and published two years later. A French translation in 1897 of the work of Wessel made it internationally recognized, and in 1999 appeared an English translation in *Matematisk-fysiske Meddelelser* **46:1** from the Academy: *On the Analytical Representation of Direction*, edited by B. Branner and J. Lützen. Caspar Wessel was brother of the Danish-Norwegian poet Johan Herman Wessel, who wrote the following about the brother Caspar:

Han tegner Landkaart og læser Loven
 Han er saa flittig som jeg er Doven

and in English¹

He roughs in maps and studies jurisprudence
 He labours hard while I am short of diligence

i.2. Short description of the content.

We shall consider functions $f : G \rightarrow \mathbb{C}$ defined in an open subset G of \mathbb{C} , and we shall study differentiability in complete analogy with differentiability of functions $f : I \rightarrow \mathbb{R}$, defined on an open interval $I \subseteq \mathbb{R}$. Since the calculation with complex numbers follows the same rules as those for real numbers, it is natural to examine if the difference quotient

$$\frac{f(z) - f(z_0)}{z - z_0}, \quad z, z_0 \in G, \quad z \neq z_0,$$

has a limit for $z \rightarrow z_0$. If this is the case, we say that f is (complex) differentiable at z_0 , and for the limit we use the symbol $f'(z_0)$ as in the real case. It turns out, *most surprisingly*, that if f is differentiable at all points $z_0 \in G$, then f is not only continuous as in the real case, but f is automatically *differentiable infinitely often*, and is represented by its Taylor series

$$f(z) = \sum_{n=0}^{\infty} \frac{f^{(n)}(z_0)}{n!} (z - z_0)^n,$$

for all z in the largest open disc $K(z_0, \rho)$ around z_0 and contained in G . Complex differentiability is a much stronger requirement than real differentiability because the difference quotient is required to have one and the same limit independent of the direction from which z approaches z_0 . On an interval one can only approach a point z_0 from left and right, but in the plane we have infinitely many directions to choose among.

A function, which is complex differentiable at all points of an open set, is called *holomorphic* in the set. In the literature one also meets the names *analytic function* or *differentiable function* meaning the same as holomorphic function.

The theory of holomorphic functions was completely developed in the 19'th century mainly by Cauchy, Riemann and Weierstrass. The theory consists of a wealth of beautiful and surprising results, and they are often strikingly different from results about analogous concepts for functions of a real variable.

¹I thank Professor Knud Sørensen for this translation

We are also going to study antiderivatives (or primitives) F of a given function f , i.e. functions F such that $F' = f$. It is still “true” that we find an antiderivative $F(z)$ satisfying $F(z_0) = 0$ by integrating f from z_0 to z , but we have a lot of freedom in the complex plane integrating from z_0 to z . We will integrate along a differentiable curve leading to the concept of a complex path integral. We then have to examine how this integral depends on the chosen path from one point to another. The fundamental discovery of Cauchy is roughly speaking that the path integral from z_0 to z of a holomorphic function is independent of the path as long as it starts at z_0 and ends at z .

It will be too much to introduce all the topics of this treatment. Instead we let each section start with a small summary.

Here comes a pertinent warning: In the study of certain properties like continuity or integrability of a function with complex values, the reader has been accustomed to a rule stating that such properties are dealt with by considering them separately for the real and imaginary part of the function.

It will be a disaster to believe that this rule holds for holomorphic functions. The real and imaginary part of a holomorphic function are in fact intimately connected by two partial differential equations called the Cauchy-Riemann equations. These equations show that a real-valued function defined on a connected open set is holomorphic if and only if it is constant.

A holomorphic function is extremely rigid: As soon as it is known in a tiny portion of the plane it is completely determined.

We have collected a few important notions and results from Analysis in an Appendix for easy reference like A.1,A.2 etc.

Each section ends with exercises. Some of them are easy serving as illustrations of the theory. Others require some more work and are occasionally followed by a hint.

The literature on complex function theory is enormous. The reader can find more material in the following classics, which are referred to by the name of the author:

E. Hille, *Analytic function theory I,II*. New York 1976-77. (First Edition 1959).

A.I. Markushevich, *Theory of functions of a complex variable*. Three volumes in one. New York 1985. (First English Edition 1965-67 in 3 volumes).

W. Rudin, *Real and complex analysis*. Singapore 1987. (First Edition 1966).

§1. Holomorphic functions

In this section we shall define holomorphic functions in an open subset of the complex plane and we shall develop the basic elementary properties of these functions. Polynomials are holomorphic in the whole complex plane.

Holomorphy can be characterized by two partial differential equations called the Cauchy-Riemann equations.

The sum function of a convergent power series is holomorphic in the disc of convergence. This is used to show that the elementary functions \sin , \cos and \exp are holomorphic in the whole complex plane.

1.1. Simple properties.

Definition 1.1. Let $G \subseteq \mathbb{C}$ be an open set. A function $f : G \rightarrow \mathbb{C}$ is called (*complex*) *differentiable* at a point $z_0 \in G$, if the difference quotient

$$\frac{f(z_0 + h) - f(z_0)}{h}$$

has a limit in \mathbb{C} for $h \rightarrow 0$. This limit is called the *derivative* of f at z_0 , and is denoted $f'(z_0)$. If f is (*complex*) differentiable at all points of G , then f is called *holomorphic* in G , and the function $f' : G \rightarrow \mathbb{C}$ is called the *derivative* of f .

For a function denoted $w = f(z)$ we also write

$$f'(z) = \frac{dw}{dz} = \frac{df}{dz}$$

for the derivative at $z \in G$.

The set of holomorphic functions $f : G \rightarrow \mathbb{C}$ is denoted $\mathcal{H}(G)$.

Remark 1.2. For $z_0 \in G$ there exists $r > 0$ such that $K(z_0, r) \subseteq G$, and the difference quotient is then defined at least for $h \in K'(0, r)$.

The assertion that f is differentiable at z_0 with derivative $f'(z_0) = a$, is equivalent to an equation of the form

$$f(z_0 + h) = f(z_0) + ha + h\varepsilon(h) \quad \text{for } h \in K'(0, r), \quad (1)$$

where $r > 0$ is such that $K(z_0, r) \subseteq G$, and $\varepsilon : K'(0, r) \rightarrow \mathbb{C}$ is a function satisfying

$$\lim_{h \rightarrow 0} \varepsilon(h) = 0.$$

To see this, note that if f is differentiable at z_0 with derivative $f'(z_0) = a$, then the equation (1) holds with $\varepsilon(h)$ defined by

$$\varepsilon(h) = \frac{f(z_0 + h) - f(z_0)}{h} - a, \quad h \in K'(0, r).$$

Conversely, if (1) holds for a function ε satisfying $\varepsilon(h) \rightarrow 0$ for $h \rightarrow 0$, then a simple calculation shows that the difference quotient approaches a for $h \rightarrow 0$.

From (1) follows, that if f is differentiable at z_0 , then f is continuous at z_0 , because

$$|f(z_0 + h) - f(z_0)| = |h| |a + \varepsilon(h)|$$

can be made as small as we wish, if $|h|$ is chosen sufficiently small.

Exactly as for real-valued functions on an interval one can prove that if f and g are differentiable at $z_0 \in G$ and $\lambda \in \mathbb{C}$, then also λf , $f \pm g$, fg and f/g are differentiable at z_0 with the derivatives

$$\begin{aligned} (\lambda f)'(z_0) &= \lambda f'(z_0), \\ (f \pm g)'(z_0) &= f'(z_0) \pm g'(z_0), \\ (fg)'(z_0) &= f(z_0)g'(z_0) + f'(z_0)g(z_0), \\ \left(\frac{f}{g}\right)'(z_0) &= \frac{g(z_0)f'(z_0) - f(z_0)g'(z_0)}{g(z_0)^2}, \quad \text{provided that } g(z_0) \neq 0. \end{aligned}$$

It is expected that you, the reader, can provide the complete proof of these elementary facts.

As an example let us show how the last assertion can be proved when $g(z_0) \neq 0$:

As already remarked, g is in particular continuous at z_0 , so there exists $r > 0$ such that $g(z_0 + h) \neq 0$ for $|h| < r$. For h with this property we get

$$\frac{f(z_0 + h)}{g(z_0 + h)} - \frac{f(z_0)}{g(z_0)} = \frac{f(z_0 + h) - f(z_0)}{g(z_0 + h)} - f(z_0) \frac{g(z_0 + h) - g(z_0)}{g(z_0 + h)g(z_0)}.$$

Dividing by $h \neq 0$ and letting $h \rightarrow 0$ leads to the assertion.

Applying the above to functions assumed differentiable at all points in an open set, we get:

Theorem 1.3. *The set $\mathcal{H}(G)$ of holomorphic functions in an open set $G \subseteq \mathbb{C}$ is stable under addition, subtraction, multiplication and division provided the denominator never vanishes.²*

The derivative of a constant function $f(z) = k$ is $f'(z) = 0$ and the derivative of $f(z) = z$ is $f'(z) = 1$.

More generally, z^n is holomorphic in \mathbb{C} for $n \in \mathbb{N}_0$ with the derivative

$$\frac{d}{dz}(z^n) = nz^{n-1}.$$

²Using an algebraic language we can say that $\mathcal{H}(G)$ is a complex vector space and a commutative ring.

This can be seen by induction and using the above rule of derivation of a product:

$$\frac{d}{dz}(z^{n+1}) = z \frac{d}{dz}(z^n) + \frac{d}{dz}(z)z^n = z(nz^{n-1}) + z^n = (n+1)z^n.$$

Using the rule of derivation of a sum, we see that a polynomial

$$p(z) = \sum_{k=0}^n a_k z^k, \quad a_k \in \mathbb{C}, \quad k = 0, 1, \dots, n,$$

is holomorphic in \mathbb{C} with the “usual” derivative

$$p'(z) = \sum_{k=1}^n k a_k z^{k-1}.$$

By the rule of derivation of a fraction it follows that $z^{-n} = 1/z^n$ is holomorphic in $\mathbb{C} \setminus \{0\}$ for $n \in \mathbb{N}$ with

$$\frac{d}{dz}(z^{-n}) = -n z^{-n-1}.$$

Also the composition of two functions is differentiated in the usual way:

$$(f \circ g)'(z_0) = f'(g(z_0))g'(z_0). \quad (2)$$

Here it is assumed that $f: G \rightarrow \mathbb{C}$ is differentiable at $g(z_0) \in G$, $g: U \rightarrow \mathbb{C}$ is assumed differentiable at $z_0 \in U$, and we have of course to assume that $g(U) \subseteq G$ in order to be able to define $f \circ g$. Note also that U can be an open interval (g is a differentiable function in the ordinary sense) or an open subset of \mathbb{C} (g is complex differentiable).

To see the above we note that

$$\begin{aligned} g(z_0 + h) &= g(z_0) + hg'(z_0) + h\varepsilon(h) \in G \\ f(g(z_0) + t) &= f(g(z_0)) + tf'(g(z_0)) + t\delta(t), \end{aligned}$$

provided h and t are sufficiently small in absolute value. Furthermore

$$\lim_{h \rightarrow 0} \varepsilon(h) = \lim_{t \rightarrow 0} \delta(t) = 0.$$

Defining $t(h) = hg'(z_0) + h\varepsilon(h)$, we get for h sufficiently small in absolute value:

$$\begin{aligned} f(g(z_0 + h)) &= f(g(z_0) + t(h)) \\ &= f(g(z_0)) + t(h)f'(g(z_0)) + t(h)\delta(t(h)) \\ &= f(g(z_0)) + hf'(g(z_0))g'(z_0) + h\tilde{\varepsilon}(h) \end{aligned}$$

with

$$\tilde{\varepsilon}(h) = \varepsilon(h)f'(g(z_0)) + \delta(t(h))(g'(z_0) + \varepsilon(h)).$$

Since $\lim_{h \rightarrow 0} \tilde{\varepsilon}(h) = 0$, formula (2) follows.

Concerning inverse functions we have:

Theorem 1.4. *Suppose that $f: G \rightarrow \mathbb{C}$ is holomorphic in an open set $G \subseteq \mathbb{C}$ and that f is one-to-one. Then $f(G)$ is open in \mathbb{C} and the inverse function³ $f^{\circ-1}: f(G) \rightarrow G$ is holomorphic with*

$$(f^{\circ-1})' = \frac{1}{f' \circ f^{\circ-1}} \quad \text{i.e.} \quad (f^{\circ-1})'(f(z)) = \frac{1}{f'(z)} \quad \text{for } z \in G.$$

In particular $f'(z) \neq 0$ for all $z \in G$.

Remark 1.5. The theorem is difficult to prove, so we skip the proof here. Look however at exc. 7.15. It is a quite deep topological result that if only $f: G \rightarrow \mathbb{C}$ is one-to-one and continuous, then $f(G)$ is open in \mathbb{C} and $f^{\circ-1}: f(G) \rightarrow G$ is continuous. See Markushevich, vol. I p. 94.

The formula for the derivative of the inverse function is however easy to obtain, when we know that $f^{\circ-1}$ is holomorphic: It follows by differentiation of the composition $f^{\circ-1} \circ f(z) = z$. Therefore one can immediately derive the formula for the derivative of the inverse function, and one does not have to remember it.

If one knows that $f'(z_0) \neq 0$ and that $f^{\circ-1}$ is continuous at $w_0 = f(z_0)$, then it is elementary to see that $f^{\circ-1}$ is differentiable at w_0 with the quoted derivative.

In fact, if $w_n = f(z_n) \rightarrow w_0$, then we have $z_n \rightarrow z_0$, and

$$\frac{f^{\circ-1}(w_n) - f^{\circ-1}(w_0)}{w_n - w_0} = \frac{z_n - z_0}{f(z_n) - f(z_0)} \rightarrow \frac{1}{f'(z_0)}.$$

1.2. The geometric meaning of differentiability when $f'(z_0) \neq 0$.

For real-valued functions of one or two real variables we can draw the graph in respectively \mathbb{R}^2 or \mathbb{R}^3 .

For a complex-valued function f defined on a subset G of \mathbb{C} the graph $\{(z, f(z)) \mid z \in G\}$ is a subset of \mathbb{C}^2 , which can be identified with \mathbb{R}^4 . Since we cannot visualize four dimensions, the graph does not play any role. Instead one tries to understand a holomorphic function $f: G \rightarrow \mathbb{C}$, $w = f(z)$, in the following way:

Think of two different copies of the complex plane: The plane of definition or the z -plane and the image plane or the w -plane. One tries to determine

- (i) the image under f of certain curves in G , e.g. horizontal or vertical lines;

³We use the notation $f^{\circ-1}$ for the inverse function to avoid confusion with the reciprocal $f^{-1} = 1/f$.

- (ii) the image set $f(K)$ for certain simple subsets $K \subseteq G$; in particular such K , on which f is one-to-one. In the exercises we shall see examples of this.

We shall now analyse image properties of a holomorphic function in the neighbourhood of a point z_0 , where $f'(z_0) \neq 0$. In the neighbourhood of a point z_0 where $f'(z_0) = 0$, the situation is more complicated, and it will not be analysed here. See however exc. 7.17.

Let $w = f(z)$ be a holomorphic function defined in an open set $G \subseteq \mathbb{C}$, and assume that $z_0 \in G$, $f(z_0) = w_0$. We consider a differentiable curve $z: I \rightarrow G$ in G passing through z_0 . This means that there is a number t_0 in the interval I , such that $z(t_0) = z_0$. The function f maps the curve $z(t)$ in a differentiable curve $f(z(t))$ passing through w_0 . Assuming $z'(t_0) \neq 0$, then $z(t)$ has a tangent at z_0 which is parallel to $z'(t_0)$ considered as the vector $(\operatorname{Re} z'(t_0), \operatorname{Im} z'(t_0))$. The tangent can be considered as a velocity vector, if we think of the variable t as time. The line containing the tangent can be parameterized by the equation

$$z_0 + sz'(t_0), \quad s \in \mathbb{R}.$$

Since $f'(z_0) \neq 0$ we have $(f \circ z)'(t_0) = f'(z_0)z'(t_0) \neq 0$, which shows that the image curve $f(z(t))$ has a tangent at w_0 , and the tangent line is parameterized by

$$w_0 + sf'(z_0)z'(t_0), \quad s \in \mathbb{R}.$$

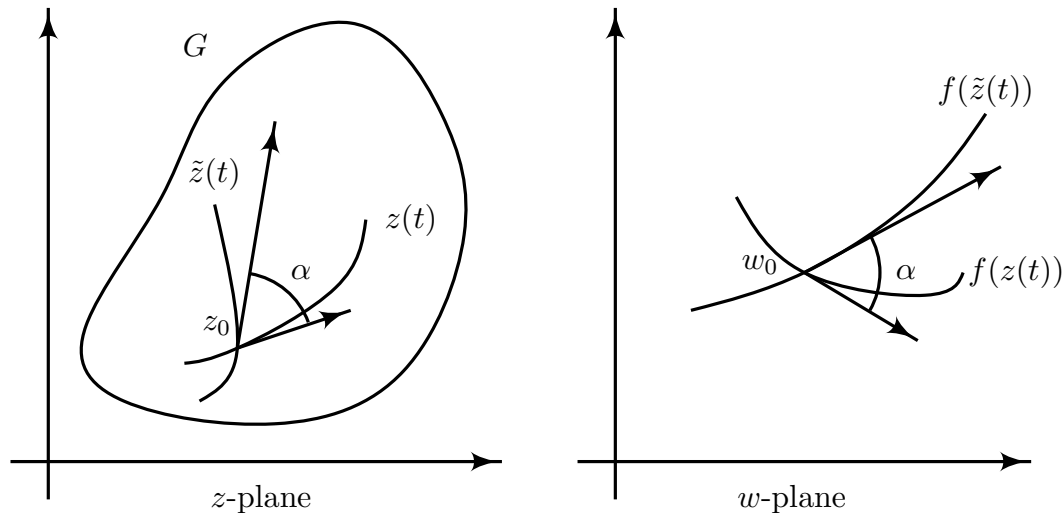

Figure 1.1

Writing $f'(z_0) = r(\cos \theta + i \sin \theta)$ with $r > 0$, $\theta \in [0, 2\pi[$, (modulus and argument) we see the following: *The tangent vector of the image curve is determined from the tangent vector of the original curve by a multiplication*

(dilation, homothetic transformation) with r and a rotation with angle θ . The tangent line of the image curve is determined from the tangent line of the original curve by a rotation with angle θ .

We say that f at the point z_0 has the *dilation constant* $r = |f'(z_0)|$ and the *rotation angle* θ .

If we consider another curve $\tilde{z}(t)$ passing through z_0 and intersecting $z(t)$ under the angle α , meaning that the angle between the tangents at z_0 to the two curves is α , then the image curves $f(\tilde{z}(t))$ and $f(z(t))$ also intersect each other under the angle α , simply because the tangent lines to the image curves are obtained from the original tangent lines by a rotation with the angle θ . All the rotations discussed are counterclockwise, corresponding to the positive orientation of the plane.

We say that f is *angle preserving* or *conformal* at the point z_0 . In particular, two orthogonal curves at z_0 (i.e. intersecting each other under the angle $\pi/2$) are mapped to orthogonal curves at w_0 . A function $f : G \rightarrow \mathbb{C}$, which is one-to-one and conformal at each point of G , is called a *conformal mapping*. We will later meet concrete examples of conformal mappings.

We see also another important feature. *Points z close to and to the left of z_0 relative to the oriented curve $z(t)$ are mapped to points $w = f(z)$ to the left of the image curve $f(z(t))$ relative to its orientation.*

In fact, the line segment $z_0 + t(z - z_0)$, $t \in [0, 1]$ from z_0 to z intersects the tangent at z_0 under a certain angle $v \in]0, \pi[$ and the image curves $f(z_0 + t(z - z_0))$ and $f(z(t))$ intersect each other under the same angle v .

1.3. The Cauchy-Riemann differential equations.

For a function $f : G \rightarrow \mathbb{C}$, where $G \subseteq \mathbb{C}$ is open, we often write $f = u + iv$, where $u = \operatorname{Re} f$ and $v = \operatorname{Im} f$ are real-valued functions on G , and they can be considered as functions of two real variables x, y restricted such that $x + iy \in G$, i.e.

$$f(x + iy) = u(x, y) + iv(x, y) \quad \text{for } x + iy \in G.$$

The following theorem characterizes differentiability of f in terms of properties of u and v .

Theorem 1.6. *The function f is complex differentiable at $z_0 = x_0 + iy_0 \in G$, if and only if u and v are differentiable at (x_0, y_0) and the partial derivatives at (x_0, y_0) satisfy*

$$\frac{\partial u}{\partial x}(x_0, y_0) = \frac{\partial v}{\partial y}(x_0, y_0); \quad \frac{\partial u}{\partial y}(x_0, y_0) = -\frac{\partial v}{\partial x}(x_0, y_0).$$

For a differentiable f we have

$$f'(z_0) = \frac{\partial f}{\partial x}(z_0) = \frac{1}{i} \frac{\partial f}{\partial y}(z_0).$$

Proof. Determine $r > 0$ such that $K(z_0, r) \subseteq G$. For $t = h + ik \in K'(0, r)$ and $c = a + ib$ there exists a function $\varepsilon: K'(0, r) \rightarrow \mathbb{C}$ such that

$$f(z_0 + t) = f(z_0) + tc + t\varepsilon(t) \quad \text{for } t \in K'(0, r), \quad (1)$$

and we know that f is differentiable at z_0 with $f'(z_0) = c$, if and only if $\varepsilon(t) \rightarrow 0$ for $t \rightarrow 0$. By splitting (1) in its real and imaginary parts and by writing $t\varepsilon(t) = |t|\frac{t}{|t|}\varepsilon(t)$, we see that (1) is equivalent with the following two real equations

$$u((x_0, y_0) + (h, k)) = u(x_0, y_0) + ha - kb + |t|\sigma(h, k), \quad (2')$$

$$v((x_0, y_0) + (h, k)) = v(x_0, y_0) + hb + ka + |t|\tau(h, k), \quad (2'')$$

where

$$\sigma(h, k) = \operatorname{Re}\left(\frac{t}{|t|}\varepsilon(t)\right) \quad \text{and} \quad \tau(h, k) = \operatorname{Im}\left(\frac{t}{|t|}\varepsilon(t)\right).$$

Notice that

$$|\varepsilon(t)| = \sqrt{\sigma(h, k)^2 + \tau(h, k)^2}. \quad (3)$$

By (2') we see that u is differentiable at (x_0, y_0) with the partial derivatives

$$\frac{\partial u}{\partial x}(x_0, y_0) = a, \quad \frac{\partial u}{\partial y}(x_0, y_0) = -b,$$

if and only if $\sigma(h, k) \rightarrow 0$ for $(h, k) \rightarrow (0, 0)$; and by (2'') we see that v is differentiable at (x_0, y_0) with the partial derivatives

$$\frac{\partial v}{\partial x}(x_0, y_0) = b, \quad \frac{\partial v}{\partial y}(x_0, y_0) = a,$$

if and only if $\tau(h, k) \rightarrow 0$ for $(h, k) \rightarrow (0, 0)$. The theorem is now proved since equation (3) shows that

$$\lim_{t \rightarrow 0} \varepsilon(t) = 0 \Leftrightarrow \lim_{(h, k) \rightarrow (0, 0)} \sigma(h, k) = \lim_{(h, k) \rightarrow (0, 0)} \tau(h, k) = 0.$$

□

Remark 1.7. A necessary and sufficient condition for $f = u + iv$ to be holomorphic in an open set $G \subseteq \mathbb{C}$ is therefore that u and v are differentiable, and that the partial derivatives of u and v satisfy the combined partial differential equations

$$\frac{\partial u}{\partial x} = \frac{\partial v}{\partial y}, \quad \frac{\partial u}{\partial y} = -\frac{\partial v}{\partial x} \quad \text{in } G.$$

These two equations are called the *Cauchy-Riemann equations*.

If we consider $f : G \rightarrow \mathbb{C}$ as a complex-valued function of two real variables, then differentiability of f at (x_0, y_0) is exactly that u and v are both differentiable at (x_0, y_0) .

The difference between (complex) differentiability at $x_0 + iy_0$ and differentiability at (x_0, y_0) is precisely the requirement that the four partial derivatives of u and v with respect to x and y satisfy the Cauchy-Riemann equations.

The Jacobi matrix for the mapping $(x, y) \mapsto (u, v)$ is given by

$$J = \begin{pmatrix} \frac{\partial u}{\partial x} & \frac{\partial u}{\partial y} \\ \frac{\partial v}{\partial x} & \frac{\partial v}{\partial y} \end{pmatrix},$$

so by using the Cauchy-Riemann equations we find the following expression for its determinant called the *Jacobian*

$$\det J = \left(\frac{\partial u}{\partial x}\right)^2 + \left(\frac{\partial v}{\partial x}\right)^2 = \left(\frac{\partial u}{\partial y}\right)^2 + \left(\frac{\partial v}{\partial y}\right)^2 = |f'|^2.$$

These equations show that the columns of J have the same length $|f'|$. The scalar product of the columns of J is 0 by the Cauchy-Riemann equations, so the columns are orthogonal.

Up to now we have formulated all results about holomorphic functions for an arbitrary open set $G \subseteq \mathbb{C}$. We need however a special type of open subsets of \mathbb{C} called *domains*.

Definition 1.8. An open set $G \subseteq \mathbb{C}$ is called a *domain*, if any two points P and Q in G can be connected by a *staircase line* in G , i.e. it shall be possible to draw a curve from P to Q inside G and consisting of horizontal and vertical line segments.

Any two different points in an open disc can be connected by a staircase line consisting of one or two horizontal/vertical line segments, so an open disc is a domain.

The definition above is preliminary, and we will show later that a domain is the same as a *path connected* open subset of \mathbb{C} , cf. §5.1. In some books the word *region* has the same meaning as domain.

Theorem 1.9. Let G be a domain in \mathbb{C} and assume that the holomorphic function $f : G \rightarrow \mathbb{C}$ satisfies $f'(z) = 0$ for all $z \in G$. Then f is constant.

Proof. Since

$$f' = \frac{\partial u}{\partial x} + i \frac{\partial v}{\partial x} = \frac{\partial v}{\partial y} - i \frac{\partial u}{\partial y} = 0,$$

we see that the differentiable functions u and v satisfy

$$\frac{\partial u}{\partial x} = \frac{\partial u}{\partial y} = \frac{\partial v}{\partial x} = \frac{\partial v}{\partial y} = 0$$

in G . From $\frac{\partial u}{\partial x} = 0$ we conclude by the mean value theorem that u is constant on every horizontal line segment in G . In the same way we deduce from $\frac{\partial u}{\partial y} = 0$ that u is constant on every vertical line segment. Because G is a domain we see that u is constant in G . The same proof applies to v , and finally f is constant. \square

The theorem above does not hold for arbitrary open sets as the following example shows.

The function

$$f(z) = \begin{cases} 1, & z \in K(0, 1) \\ 2, & z \in K(3, 1) \end{cases}$$

is holomorphic in $G = K(0, 1) \cup K(3, 1)$ with $f' = 0$, but not constant in G . Notice that G is not a domain because 0 and 3 cannot be connected by a staircase line inside G .

The following Corollary is important (but much more is proved in Theorem 7.6):

Corollary 1.10. *Assume that $f: G \rightarrow \mathbb{C}$ is holomorphic in a domain $G \subseteq \mathbb{C}$ and that the values of f are real numbers. Then f is a constant function.*

Proof. By assumption $v = 0$ in G , so by the Cauchy-Riemann equations $\frac{\partial u}{\partial x}$ and $\frac{\partial u}{\partial y}$ are 0 in G . Therefore u and hence f is constant. \square

1.4. Power series.

The reader is assumed to be acquainted with the basic properties of convergence of power series $\sum_0^\infty a_n z^n$, where $a_n \in \mathbb{C}$, $z \in \mathbb{C}$.

We recall that to any such power series there is associated a number $\rho \in [0, \infty]$ called its *radius of convergence*. For $\rho > 0$ the series is absolutely convergent for any $z \in K(0, \rho)$, so we can define the sum function $f: K(0, \rho) \rightarrow \mathbb{C}$ of the series by

$$f(z) = \sum_{n=0}^{\infty} a_n z^n, \quad |z| < \rho.$$

If $\rho = 0$ the power series is convergent only for $z = 0$ and is of no interest in complex analysis. The power series is divergent for any z satisfying $|z| > \rho$.

One way of proving these statements is to introduce the set

$$T = \{t \geq 0 \mid \{|a_n|t^n\} \text{ is a bounded sequence}\},$$

and to define $\rho = \sup T$. Clearly $[0, \rho] \subseteq T$. For $|z| < \rho$ choose $t \in T$ such that $|z| < t < \rho$, so by definition there exists a constant M such that $|a_n|t^n \leq M$, $n \geq 0$, hence

$$|a_n z^n| = |a_n|t^n \left(\frac{|z|}{t}\right)^n \leq M \left(\frac{|z|}{t}\right)^n,$$

and finally

$$\sum_{n=0}^{\infty} |a_n z^n| \leq M \sum_{n=0}^{\infty} \left(\frac{|z|}{t}\right)^n = \frac{M}{1 - |z|/t} < \infty.$$

For $|z| > \rho$ the sequence $\{|a_n||z|^n\}$ is unbounded, but then the series $\sum_0^{\infty} a_n z^n$ is divergent.

We will show that the sum function f is holomorphic in the disc of absolute convergence $K(0, \rho)$, and we begin with an important Lemma.

Lemma 1.11. *A power series and its term by term differentiated power series have the same radius of convergence.*

Proof. We shall show that $\rho = \sup T$ defined above equals $\rho' = \sup T'$, where

$$T' = \{t \geq 0 \mid \{n|a_n|t^{n-1}\} \text{ is a bounded sequence}\}.$$

If for some $t > 0$ the sequence $\{n|a_n|t^{n-1}\}$ is bounded, then also $\{|a_n|t^n\}$ is bounded, hence $T' \subseteq T$, so we get $\rho' \leq \rho$.

If conversely

$$|a_n|t_0^n \leq M \text{ for } n \geq 0 \tag{1}$$

for some $t_0 > 0$, we get for $0 \leq t < t_0$

$$n|a_n|t^{n-1} = n(t/t_0)^{n-1}|a_n|t_0^{n-1} \leq n(t/t_0)^{n-1}(M/t_0).$$

However, since the sequence $\{nr^{n-1}\}$ is bounded when $r < 1$ (it converges to 0), the inequality above shows that also $\{n|a_n|t^{n-1}\}$ is a bounded sequence. We have now proved that for every $t_0 \in T \setminus \{0\}$ one has $[0, t_0] \subseteq T'$, hence $t_0 \leq \rho'$ for all such t_0 , and we therefore have $\rho \leq \rho'$. \square

Theorem 1.12. *The sum function f of a power series $\sum_0^\infty a_n z^n$ is holomorphic in the disc of convergence $K(0, \rho)$ (provided $\rho > 0$), and the derivative is the sum function of the term by term differentiated power series, i.e.*

$$f'(z) = \sum_{n=1}^{\infty} n a_n z^{n-1} \text{ for } |z| < \rho.$$

Proof. We show that f is differentiable at z_0 , where $|z_0| < \rho$ is fixed. We first choose r such that $|z_0| < r < \rho$. For $h \in \mathbb{C}$ satisfying $0 < |h| < r - |z_0|$ we have

$$\begin{aligned} \varepsilon(h) &:= \frac{1}{h}(f(z_0 + h) - f(z_0)) - \sum_{n=1}^{\infty} n a_n z_0^{n-1} \\ &= \sum_{n=1}^{\infty} a_n \left\{ \frac{(z_0 + h)^n - z_0^n}{h} - n z_0^{n-1} \right\}, \end{aligned}$$

and we have to show that $\varepsilon(h) \rightarrow 0$ for $h \rightarrow 0$.

For given $\varepsilon > 0$ we choose N such that

$$\sum_{n=N+1}^{\infty} n |a_n| r^{n-1} < \frac{\varepsilon}{4},$$

which is possible since the series $\sum_1^\infty n |a_n| r^{n-1}$ is convergent. By applying the identity $(x^n - y^n)/(x - y) = \sum_{k=1}^n x^{n-k} y^{k-1}$ we get

$$\frac{(z_0 + h)^n - z_0^n}{h} = \sum_{k=1}^n (z_0 + h)^{n-k} z_0^{k-1},$$

and since $|z_0 + h| \leq |z_0| + |h| < r$, $|z_0| < r$ we have the estimate

$$\left| \frac{(z_0 + h)^n - z_0^n}{h} \right| \leq \sum_{k=1}^n r^{n-k} r^{k-1} = n r^{n-1}.$$

We now split $\varepsilon(h)$ as $\varepsilon(h) = A(h) + B(h)$ with

$$A(h) = \sum_{n=1}^N a_n \left\{ \frac{(z_0 + h)^n - z_0^n}{h} - n z_0^{n-1} \right\}$$

and

$$B(h) = \sum_{n=N+1}^{\infty} a_n \left\{ \frac{(z_0 + h)^n - z_0^n}{h} - n z_0^{n-1} \right\}$$

and find $\lim_{h \rightarrow 0} A(h) = 0$, since each of the finitely many terms approaches 0. For $|h|$ sufficiently small ($|h| < \delta$ for a suitable δ) we have $|A(h)| < \frac{\varepsilon}{2}$, and for the tail we have the estimate

$$|B(h)| \leq \sum_{n=N+1}^{\infty} |a_n| \{nr^{n-1} + |nz_0^{n-1}|\} \leq 2 \sum_{n=N+1}^{\infty} |a_n|nr^{n-1} < \frac{\varepsilon}{2},$$

valid for $|h| < r - |z_0|$. For $|h| < \min(\delta, r - |z_0|)$ this leads to $|\varepsilon(h)| < \varepsilon$, thereby showing that f is differentiable at z_0 with the derivative as claimed. \square

Corollary 1.13. *The sum function f of a power series $\sum_0^{\infty} a_n z^n$ is differentiable infinitely often in $K(0, \rho)$ and the following formula holds*

$$a_k = \frac{f^{(k)}(0)}{k!}, \quad k = 0, 1, \dots$$

The power series is its own Taylor series at 0, i.e.

$$f(z) = \sum_{n=0}^{\infty} \frac{f^{(n)}(0)}{n!} z^n, \quad |z| < \rho.$$

Proof. By applying Theorem 1.12 k times we find

$$f^{(k)}(z) = \sum_{n=k}^{\infty} n(n-1) \cdots (n-k+1) a_n z^{n-k}, \quad |z| < \rho$$

and in particular for $z = 0$

$$f^{(k)}(0) = k(k-1) \cdots 1 a_k.$$

\square

Theorem 1.14. The identity theorem for power series. *Assume that the power series $f(z) = \sum_0^{\infty} a_n z^n$ and $g(z) = \sum_0^{\infty} b_n z^n$ have radii of convergence $\rho_1 > 0$ and $\rho_2 > 0$. If there exists a number $0 < \rho \leq \min(\rho_1, \rho_2)$ such that*

$$f(z) = g(z) \quad \text{for } |z| < \rho,$$

then we have $a_n = b_n$ for all n .

Proof. By the assumptions follow that $f^{(n)}(z) = g^{(n)}(z)$ for all n and all z satisfying $|z| < \rho$. By Corollary 1.13 we get

$$a_n = \frac{f^{(n)}(0)}{n!} = \frac{g^{(n)}(0)}{n!} = b_n.$$

□

1.5. The exponential and trigonometric functions.

The reader is assumed to know the power series for the exponential function (as a function of a real variable)

$$\exp(z) = \sum_{n=0}^{\infty} \frac{z^n}{n!} = 1 + z + \frac{z^2}{2!} + \cdots, \quad z \in \mathbb{R}. \quad (1)$$

Since this power series converges for all real numbers, its radius of convergence is $\rho = \infty$.

We therefore take formula (1) as definition of the exponential function for arbitrary $z \in \mathbb{C}$. By Theorem 1.12 we get that $\exp : \mathbb{C} \rightarrow \mathbb{C}$ is holomorphic, and since the term by term differentiated series is the series itself, we get

$$\frac{d \exp(z)}{dz} = \exp(z), \quad z \in \mathbb{C}, \quad (2)$$

i.e. \exp satisfies the differential equation $f' = f$ with the initial condition $f(0) = 1$.

Another fundamental property of the exponential function is

Theorem 1.15. *The exponential function satisfies the functional equation*

$$\exp(z_1 + z_2) = \exp(z_1) \exp(z_2), \quad z_1, z_2 \in \mathbb{C}. \quad (3)$$

Proof. For $c \in \mathbb{C}$ we consider the holomorphic function

$$f(z) = \exp(z) \exp(c - z), \quad z \in \mathbb{C}.$$

If equation (3) is correct, then $f(z)$ has to be a constant function equal to $\exp(c)$. This gives us the idea to try to show somehow that $f(z)$ is constant.

Differentiating f we find using (2)

$$\begin{aligned} f'(z) &= \left(\frac{d}{dz} \exp(z) \right) \exp(c - z) + \exp(z) \frac{d}{dz} \exp(c - z) \\ &= \exp(z) \exp(c - z) - \exp(z) \exp(c - z) = 0, \end{aligned}$$

so by Theorem 1.9 f is a constant, in particular

$$f(z) = f(0) = \exp(0) \exp(c) = \exp(c).$$

Setting $z = z_1$, $c = z_1 + z_2$ in this formula we obtain

$$\exp(z_1 + z_2) = \exp(z_1) \exp(z_2).$$

□

From the functional equation (3) we deduce that $\exp(z) \neq 0$ for all $z \in \mathbb{C}$ since

$$1 = \exp(0) = \exp(z - z) = \exp(z) \exp(-z).$$

From this equation we further get

$$\exp(-z) = \frac{1}{\exp(z)}, \quad z \in \mathbb{C}. \quad (4)$$

Defining the number

$$e := \exp(1) = \sum_{n=0}^{\infty} \frac{1}{n!} \quad (= 2.718\dots), \quad (5)$$

and applying the functional equation n times, yields

$$\exp(nz) = (\exp(z))^n, \quad n \in \mathbb{N},$$

in particular for $z = 1$ and $z = \frac{1}{n}$

$$\exp(n) = e^n, \quad e = (\exp(\frac{1}{n}))^n,$$

showing that

$$\exp(\frac{1}{n}) = \sqrt[n]{e} = e^{\frac{1}{n}}.$$

Raising this to the power $p \in \mathbb{N}$ gives

$$(\exp(\frac{1}{n}))^p = \exp(\frac{p}{n}) = (e^{\frac{1}{n}})^p,$$

and this expression is usually denoted $e^{p/n}$. Using (4) we finally arrive at

$$\exp(\frac{p}{q}) = \sqrt[q]{e^p} = e^{\frac{p}{q}} \quad \text{for } p \in \mathbb{Z}, q \in \mathbb{N}.$$

This is the motivation for the use of the symbol e^z instead of $\exp(z)$, when z is an arbitrary real or complex number, i.e. we define

$$e^z := \exp(z), \quad z \in \mathbb{C}, \quad (6)$$

but we shall remember that the intuitive meaning of e^z , i.e. “ e multiplied by itself z times”, is without any sense when $z \notin \mathbb{Q}$.

For $a > 0$ we define $a^z = \exp(z \ln a)$ for $z \in \mathbb{C}$. Here $\ln a$ is the natural logarithm of the positive number a .

It is assumed that the reader knows the power series for the functions \sin and \cos for real values of z

$$\sin z = z - \frac{z^3}{3!} + \frac{z^5}{5!} - + \cdots = \sum_{n=0}^{\infty} \frac{(-1)^n z^{2n+1}}{(2n+1)!} \quad (7)$$

$$\cos z = 1 - \frac{z^2}{2!} + \frac{z^4}{4!} - + \cdots = \sum_{n=0}^{\infty} \frac{(-1)^n z^{2n}}{(2n)!}. \quad (8)$$

These series have the radius of convergence ∞ , and we use them as definition of the sine and cosine function for arbitrary $z \in \mathbb{C}$.

Notice that \cos is an *even* function, i.e. $\cos(-z) = \cos z$, and \sin is *odd*, i.e. $\sin(-z) = -\sin z$. Differentiating these power series term by term, we see that

$$\frac{d}{dz} \sin z = \cos z, \quad \frac{d}{dz} \cos z = -\sin z,$$

and these formulas are exactly as the well-known real variable formulas.

Theorem 1.16. Euler’s formulas (1740s). *For arbitrary $z \in \mathbb{C}$*

$$\exp(iz) = \cos z + i \sin z$$

$$\cos z = \frac{e^{iz} + e^{-iz}}{2}, \quad \sin z = \frac{e^{iz} - e^{-iz}}{2i}.$$

In particular, the following formulas hold

$$e^z = e^x (\cos y + i \sin y), \quad z = x + iy, \quad x, y \in \mathbb{R}$$

$$e^{i\theta} = \cos \theta + i \sin \theta, \quad \theta \in \mathbb{R},$$

hence

$$e^{2\pi i} = 1, \quad e^{i\pi} = -1.$$

Proof. By simply adding the power series of $\cos z$ and $i \sin z$ we get

$$\begin{aligned} \cos z + i \sin z &= \sum_{n=0}^{\infty} \left(\frac{(-1)^n z^{2n}}{(2n)!} + i \frac{(-1)^n z^{2n+1}}{(2n+1)!} \right) = \sum_{n=0}^{\infty} \left(\frac{(iz)^{2n}}{(2n)!} + \frac{(iz)^{2n+1}}{(2n+1)!} \right) \\ &= \exp(iz). \end{aligned}$$

Replacing z by $-z$ leads to

$$\exp(-iz) = \cos(-z) + i \sin(-z) = \cos z - i \sin z,$$

which together with the first equation yield the formulas for $\cos z$ and $\sin z$.

By the functional equation for \exp we next get

$$e^z = \exp(x) \exp(iy) = e^x (\cos y + i \sin y).$$

□

Remark 1.17 By Euler's formulas we find

$$u = \operatorname{Re}(e^z) = e^x \cos y, \quad v = \operatorname{Im}(e^z) = e^x \sin y,$$

and we can now directly show that the Cauchy-Riemann equations hold:

$$\frac{\partial u}{\partial x} = \frac{\partial v}{\partial y} = e^x \cos y, \quad \frac{\partial u}{\partial y} = -\frac{\partial v}{\partial x} = -e^x \sin y.$$

Letting n tend to infinity in

$$\sum_{k=0}^n \frac{z^k}{k!} = \sum_{k=0}^n \frac{(\bar{z})^k}{k!},$$

we get

$$\overline{\exp(z)} = \exp(\bar{z}), \quad z \in \mathbb{C}, \tag{9}$$

and in particular

$$|\exp(z)|^2 = \overline{\exp(z)} \exp(z) = \exp(\bar{z} + z) = \exp(2 \operatorname{Re} z),$$

hence

$$|\exp(z)| = \exp(\operatorname{Re} z), \quad z \in \mathbb{C}, \tag{10}$$

and when z is purely imaginary

$$|\exp(iy)| = 1, \quad y \in \mathbb{R}. \tag{11}$$

(Note that this gives a new proof of the well-known fact $\cos^2 y + \sin^2 y = 1$ for $y \in \mathbb{R}$.)

We further have:

The function $f(\theta) = e^{i\theta}$ defines a continuous group homomorphism of the additive group of real numbers $(\mathbb{R}, +)$ onto the circle group (\mathbb{T}, \cdot) , where $\mathbb{T} = \{z \in \mathbb{C} \mid |z| = 1\}$. The equation stating that f is a homomorphism, i.e.

$$f(\theta_1 + \theta_2) = f(\theta_1)f(\theta_2) \quad (12)$$

is a special case of (3) with $z_1 = i\theta_1$, $z_2 = i\theta_2$. Taking the real and imaginary part of this equation, leads to *the addition formulas* for cosine and sine:

$$\cos(\theta_1 + \theta_2) = \cos \theta_1 \cos \theta_2 - \sin \theta_1 \sin \theta_2 \quad (13)$$

$$\sin(\theta_1 + \theta_2) = \sin \theta_1 \cos \theta_2 + \cos \theta_1 \sin \theta_2. \quad (14)$$

The formula of De Moivre

$$(\cos \theta + i \sin \theta)^n = \cos n\theta + i \sin n\theta, \quad \theta \in \mathbb{R}, n \in \mathbb{N}$$

is just the equation $(\exp(i\theta))^n = \exp(in\theta)$ or $f(n\theta) = f(\theta)^n$, which is a consequence of (12).

By the functional equation we also get

$$\exp(z + 2\pi i) = \exp(z) \exp(2\pi i) = \exp(z), \quad z \in \mathbb{C}$$

which can be expressed like this: *The exponential function is periodic with the purely imaginary period $2\pi i$.*

Theorem 1.18. *The equation $\exp(z) = 1$ has the solutions $z = 2\pi ip$, $p \in \mathbb{Z}$.*

The trigonometric functions \sin and \cos have no other zeros in \mathbb{C} than the ordinary real zeros:

$$\sin z = 0 \Leftrightarrow z = p\pi, \quad p \in \mathbb{Z}.$$

$$\cos z = 0 \Leftrightarrow z = \frac{\pi}{2} + p\pi, \quad p \in \mathbb{Z}.$$

Proof. Writing $z = x + iy$, the equation $\exp(z) = 1$ implies $|\exp(z)| = e^x = 1$, hence $x = 0$. This reduces the equation to

$$\exp(iy) = \cos y + i \sin y = 1$$

which has the solutions $y = 2p\pi$, $p \in \mathbb{Z}$.

Assuming $\sin z = 0$, we get by Euler's formulas that $e^{iz} = e^{-iz}$. We then get $e^{2iz} = 1$, hence $2iz = 2\pi ip$, $p \in \mathbb{Z}$, which shows that $z = p\pi$, $p \in \mathbb{Z}$.

Assuming $\cos z = 0$, we get $e^{2iz} = -1 = e^{i\pi}$, hence $e^{i(2z-\pi)} = 1$, which gives $i(2z - \pi) = 2\pi ip$, $p \in \mathbb{Z}$, showing that $z = \frac{\pi}{2} + p\pi$. \square

By Theorem 1.18 follows that

$$\tan z = \frac{\sin z}{\cos z}, \quad \cot z = \frac{\cos z}{\sin z}$$

are holomorphic in respectively $\mathbb{C} \setminus \{\frac{\pi}{2} + \pi\mathbb{Z}\}$ and $\mathbb{C} \setminus \pi\mathbb{Z}$.

1.6. Hyperbolic functions.

In many situations the functions

$$\sinh z = \frac{e^z - e^{-z}}{2}, \quad \cosh z = \frac{e^z + e^{-z}}{2}, \quad z \in \mathbb{C} \quad (1)$$

play an important role. They are holomorphic in \mathbb{C} and are called *sine hyperbolic* and *cosine hyperbolic* respectively.

Inserting the power series for e^z and e^{-z} , we obtain the following power series with infinite radius of convergence

$$\sinh z = z + \frac{z^3}{3!} + \frac{z^5}{5!} + \cdots = \sum_{n=0}^{\infty} \frac{z^{2n+1}}{(2n+1)!}, \quad (2)$$

$$\cosh z = 1 + \frac{z^2}{2!} + \frac{z^4}{4!} + \cdots = \sum_{n=0}^{\infty} \frac{z^{2n}}{(2n)!}. \quad (3)$$

Notice that they have the “same form” as the series for \sin and \cos , but without the variation in sign. We observe that \sinh is odd and \cosh is even and that the following formulas hold:

$$\frac{d}{dz} \sinh z = \cosh z, \quad \frac{d}{dz} \cosh z = \sinh z. \quad (4)$$

The functions are closely related to the corresponding trigonometric functions

$$\sinh(iz) = i \sin z, \quad \cosh(iz) = \cos z, \quad z \in \mathbb{C}. \quad (5)$$

This is a simple consequence of Euler’s formulas or the power series.

These formulas are equivalent with

$$\sin(iz) = i \sinh z, \quad \cos(iz) = \cosh z, \quad (6)$$

and from these we see that

$$\begin{aligned}\sinh z = 0 &\iff z = ip\pi, \quad p \in \mathbb{Z} \\ \cosh z = 0 &\iff z = i\left(\frac{\pi}{2} + p\pi\right), \quad p \in \mathbb{Z}.\end{aligned}$$

Using Euler's formulas for $\cos z$ and $\sin z$ and a small calculation (cf. exc. 1.10), we see that the classical formula $\cos^2 z + \sin^2 z = 1$ (assuming $z \in \mathbb{R}$) holds for all $z \in \mathbb{C}$. Replacing z by iz transforms the equation to

$$(\cosh z)^2 + (i \sinh z)^2 = 1$$

or equivalently

$$\cosh^2 z - \sinh^2 z = 1, \quad z \in \mathbb{C}. \quad (7)$$

This shows in particular that the points $(\cosh t, \sinh t)$ for $t \in \mathbb{R}$ lie on the branch of the hyperbola

$$x^2 - y^2 = 1, \quad x > 0.$$

This is the reason behind the names of the functions.

The functions *tangent hyperbolic* and *cotangent hyperbolic* are defined by

$$\begin{aligned}\tanh z &= \frac{\sinh z}{\cosh z} \\ \coth z &= \frac{\cosh z}{\sinh z},\end{aligned}$$

and they are holomorphic in respectively $\mathbb{C} \setminus \{i\frac{\pi}{2} + i\pi\mathbb{Z}\}$ and $\mathbb{C} \setminus i\pi\mathbb{Z}$.

Exercises for §1.

1.1. Prove that $f(z) = \frac{1}{z(1-z)}$ is (complex) differentiable infinitely often in $\mathbb{C} \setminus \{0, 1\}$. Find an expression for $f^{(n)}(z)$ for all $n \geq 0$.

Hint. Write $f(z) = \frac{1}{z} + \frac{1}{1-z}$.

1.2. Describe the image curves under $f(z) = z^2$ from \mathbb{C} to \mathbb{C} of the following plane curves

- a) Half-lines starting at 0, i.e. $\{re^{it_0} | r \geq 0\}$, where $t_0 \in \mathbb{R}$.
- b) The circles $|z| = r$.
- c) The horizontal line $x + \frac{1}{2}i$.
- d) The vertical lines $a + iy$, where $a > 0$ is fixed.

Explain that all image curves from d) intersect the image curve from c) orthogonally, i.e. under right angles.

1.3. Describe the image of horizontal and vertical lines in \mathbb{C} under $\exp z = e^x e^{iy}$, $z = x + iy$, and explain that the image curves are orthogonal.

Show furthermore that \exp maps the strip

$$S = \{z \in \mathbb{C} \mid |\operatorname{Im}(z)| < \pi\}$$

bijectively onto the cut plane $\mathbb{C} \setminus (-\infty, 0]$.

1.4. Consider the functions

$$f(z) = \frac{1}{z^4 - 1}, \quad g(z) = \frac{1}{(z^2 - 2z + 4 - 4i)^2}.$$

Explain that f is holomorphic in $\mathbb{C} \setminus \{\pm 1, \pm i\}$ and find f' . Explain that g is holomorphic in $\mathbb{C} \setminus \{-2i, 2 + 2i\}$ and find g' .

1.5. Prove that the functions $z \mapsto \operatorname{Re} z$ and $z \mapsto \bar{z}$ are not differentiable at any point in \mathbb{C} .

1.6. Prove that

$$u(x, y) = \frac{x}{x^2 + y^2}, \quad v(x, y) = -\frac{y}{x^2 + y^2}, \quad \text{for } (x, y) \in \mathbb{R}^2 \setminus \{(0, 0)\},$$

satisfy the Cauchy-Riemann equations without doing any differentiations.

1.7. Let $f : G \rightarrow \mathbb{C}$ be holomorphic in a domain G and assume that $|f|$ is constant. Prove that f is constant.

Hint. a) Write $f = u + iv$ and notice that by assumption $u^2 + v^2$ is constant, i.e. $u^2 + v^2 = k \geq 0$ in G . We can also assume that $k > 0$, because if $k = 0$ then clearly $u = v = f = 0$.

b) Use $\frac{\partial}{\partial x}(u^2 + v^2) = \frac{\partial}{\partial y}(u^2 + v^2) = 0$ and the Cauchy-Riemann-equations to obtain the linear system of equations

$$u \frac{\partial u}{\partial x} - v \frac{\partial u}{\partial y} = 0 \quad v \frac{\partial u}{\partial x} + u \frac{\partial u}{\partial y} = 0. \quad (*)$$

c) The linear system (*) with $\frac{\partial u}{\partial x}$, $\frac{\partial u}{\partial y}$ as unknown has the determinant $u^2 + v^2$. Conclude that $\frac{\partial u}{\partial x} = \frac{\partial u}{\partial y} = 0$.

1.8. Prove that if $f : \mathbb{C} \rightarrow \mathbb{C}$ is holomorphic and of the form $f(x + iy) = u(x) + iv(y)$, where u and v are real functions, then $f(z) = \lambda z + c$ with $\lambda \in \mathbb{R}$, $c \in \mathbb{C}$.

1.9. Prove the following formulas for $n \in \mathbb{N}$, $\theta \in \mathbb{R}$:

$$\begin{aligned} \cos(n\theta) &= \sum_{k=0}^{[n/2]} (-1)^k \binom{n}{2k} \cos^{n-2k} \theta \sin^{2k} \theta \\ \sin(n\theta) &= \sum_{k=0}^{[(n-1)/2]} (-1)^k \binom{n}{2k+1} \cos^{n-2k-1} \theta \sin^{2k+1} \theta. \end{aligned}$$

($[a]$ denotes the integer part of a , i.e. $[a]$ is the unique integer $p \in \mathbb{Z}$ satisfying $a - 1 < p \leq a$.)

1.10. Prove the addition formulas

$$\begin{aligned} \sin(z_1 + z_2) &= \sin z_1 \cos z_2 + \cos z_1 \sin z_2 \\ \cos(z_1 + z_2) &= \cos z_1 \cos z_2 - \sin z_1 \sin z_2 \end{aligned}$$

and the formula

$$(\sin z)^2 + (\cos z)^2 = 1$$

for all $z_1, z_2, z \in \mathbb{C}$.

Hint. Euler's formulas.

1.11. Determine the set of solutions $z \in \mathbb{C}$ to the equations $\sin z = 1$ and $\sin z = \sqrt{10}$.

1.12. Assuming x and $y \in \mathbb{R}$, prove that

$$\sin(x + iy) = \sin x \cosh y + i \cos x \sinh y.$$

Use this formula and the Cauchy-Riemann equations to prove that \sin is holomorphic with $\frac{d}{dz} \sin z = \cos z$.

Describe the image of horizontal and vertical lines in \mathbb{C} under the sine function. (Recall that the equation $\frac{x^2}{a^2} - \frac{y^2}{b^2} = 1$ describes a hyperbola, and the equation $\frac{x^2}{a^2} + \frac{y^2}{b^2} = 1$ describes an ellipse.)

Prove that sine maps the strip

$$\left\{ x + iy \mid -\frac{\pi}{2} < x < \frac{\pi}{2}, y \in \mathbb{R} \right\}$$

bijectively onto $\mathbb{C} \setminus (]-\infty, -1] \cup [1, \infty[)$.

1.13. Prove that the Cauchy-Riemann equations for $f = u + iv$ can be written as one equation:

$$\frac{\partial f}{\partial x} + i \frac{\partial f}{\partial y} = 0.$$

It is customary in advanced complex analysis to introduce the differential expressions

$$\partial = \frac{1}{2} \left(\frac{\partial}{\partial x} - i \frac{\partial}{\partial y} \right), \quad \bar{\partial} = \frac{1}{2} \left(\frac{\partial}{\partial x} + i \frac{\partial}{\partial y} \right).$$

Prove that $\bar{\partial}f = 0$ and $f'(z) = \partial f(z)$ for a holomorphic function f .

1.14. Prove the following formula for $z = x + iy \in \mathbb{C} \setminus \{\frac{\pi}{2} + \pi\mathbb{Z}\}$:

$$2 \tan(x + iy) = \frac{\sin(2x)}{\cos^2 x + \sinh^2 y} + i \frac{\sinh(2y)}{\cos^2 x + \sinh^2 y}$$

$$\tan z = \frac{1}{i} \frac{e^{2iz} - 1}{e^{2iz} + 1}.$$

1.15. Prove that a power series $\sum_{n=0}^{\infty} a_n z^n$ has radius of convergence $\rho = \infty$ if and only if $\lim_{n \rightarrow \infty} \sqrt[n]{|a_n|} = 0$.

1.16. Assume that $f, g : G \rightarrow \mathbb{C}$ are n times differentiable in the open subset G of \mathbb{C} . Prove Leibniz' formula for the n 'th derivative of a product:

$$(fg)^{(n)} = \sum_{k=0}^n \binom{n}{k} f^{(k)} g^{(n-k)}.$$

1.17. Prove that the function $\tan z$ satisfies $\tan' z = 1 + \tan^2 z$, $\tan'' z = 2 \tan z + 2 \tan^3 z$ and generally

$$\tan^{(n)} z = \sum_{k=0}^{n+1} a_{n,k} \tan^k z, \quad n = 0, 1, \dots,$$

where $a_{n,k}$ are non-negative integers.

Prove that $a_{n,k} = 0$ when n, k are both even or both odd.

Conclude that the Taylor series for \tan around 0 has the form $\sum_{n=1}^{\infty} t_n z^{2n-1}$, where $t_n = a_{2n-1,0}/(2n-1)!$.

Prove that the Taylor series starts

$$\tan(z) = z + \frac{1}{3}z^3 + \frac{2}{15}z^5 + \dots$$

(It can be proved that

$$a_{2n-1,0} = \frac{B_{2n}}{2n} (2^{2n} - 1) 2^{2n},$$

where B_{2n} are the Bernoulli numbers studied in exc. 6.12.)

1.18. Prove that for any $z \in \mathbb{C}$

$$\lim_{n \rightarrow \infty} \left(1 + \frac{z}{n}\right)^n = \exp(z).$$

Hint. Prove that for $n \geq 2$

$$\exp(z) - \left(1 + \frac{z}{n}\right)^n = \sum_{k=2}^n \frac{z^k}{k!} \left(1 - \prod_{j=1}^{k-1} \left(1 - \frac{j}{n}\right)\right) + \sum_{k=n+1}^{\infty} \frac{z^k}{k!},$$

and use that the tail

$$\sum_{k=N+1}^{\infty} \frac{|z|^k}{k!}$$

can be made as small as we like, if N is chosen big enough.

1.19. Prove that the radius of convergence ρ for a power series $\sum_0^{\infty} a_n z^n$ is given by Cauchy-Hadamard's formula

$$\rho = \left(\limsup_{n \rightarrow \infty} \sqrt[n]{|a_n|} \right)^{-1}.$$

(In particular, if $\lim_{n \rightarrow \infty} \sqrt[n]{|a_n|}$ exists, then ρ is the reciprocal of this limit.)

1.20. Let $f(z) = \sum_{n=0}^{\infty} a_n z^n$ be the sum function of a power series with radius of convergence $0 < \rho \leq \infty$.

Show that $f : K(0, \rho) \rightarrow \mathbb{C}$ is an *even function* (i.e., $f(-z) = f(z)$ for all $z \in K(0, \rho)$) if and only if $a_{2n+1} = 0$ for $n = 0, 1, \dots$, and that f is an *odd function* (i.e., $f(-z) = -f(z)$ for all $z \in K(0, \rho)$) if and only if $a_{2n} = 0$ for $n = 0, 1, \dots$

§2. Contour integrals and primitives

In this section we introduce complex contour integrals. This makes it possible to define the inverse operation of differentiation leading from a function f to a new one F called the antiderivative or the primitive such that $F' = f$. We first define oriented continuous curves and a path is such a curve which is piecewise C^1 .

The estimation lemma 2.8 about contour integrals is very important: It is used repeatedly in these notes.

Theorem 2.13 gives a complete characterization of continuous functions having a primitive.

2.1. Integration of functions with complex values.

For a continuous function $f : [a, b] \rightarrow \mathbb{C}$ we define

$$\int_a^b f(t)dt = \int_a^b \operatorname{Re} f(t)dt + i \int_a^b \operatorname{Im} f(t)dt. \quad (1)$$

Therefore $\int_a^b f(t)dt$ is the unique complex number such that

$$\operatorname{Re} \left(\int_a^b f(t)dt \right) = \int_a^b \operatorname{Re} f(t)dt, \quad \operatorname{Im} \left(\int_a^b f(t)dt \right) = \int_a^b \operatorname{Im} f(t)dt,$$

and hence $\int_a^b \overline{f(t)}dt = \overline{\int_a^b f(t)dt}$. The usual rules of operations with integrals of real-valued functions carry over to complex-valued functions. We have for example

$$\int_a^b (f(t) + g(t))dt = \int_a^b f(t)dt + \int_a^b g(t)dt \quad (2)$$

$$\int_a^b cf(t)dt = c \int_a^b f(t)dt, \quad c \in \mathbb{C} \quad (3)$$

$$\int_a^b f(t)dt = F(b) - F(a) \quad \text{if } F' = f. \quad (4)$$

The following estimate, which is exactly as the real version, is somewhat tricky to prove.

Theorem 2.1. *Let $f : [a, b] \rightarrow \mathbb{C}$ be a continuous function. Then*

$$\left| \int_a^b f(t)dt \right| \leq \int_a^b |f(t)|dt.$$

Proof. The complex number $z = \int_a^b f(t)dt$ can be written in the form $re^{i\theta}$, where $r = |z|$ and θ is an argument for z . By formula (3) we then have

$$r = ze^{-i\theta} = \int_a^b e^{-i\theta} f(t)dt = \int_a^b \operatorname{Re}(e^{-i\theta} f(t)) dt,$$

because

$$\int_a^b \operatorname{Im}(e^{-i\theta} f(t)) dt = 0,$$

since the integral of $e^{-i\theta} f(t)$ is the real number $r \geq 0$. We therefore have

$$\begin{aligned} \left| \int_a^b f(t)dt \right| &= \int_a^b \operatorname{Re}(e^{-i\theta} f(t)) dt \leq \int_a^b \left| \operatorname{Re}(e^{-i\theta} f(t)) \right| dt \\ &\leq \int_a^b \left| e^{-i\theta} f(t) \right| dt = \int_a^b \left| e^{-i\theta} \right| |f(t)| dt = \int_a^b |f(t)| dt, \end{aligned}$$

where we used that $\operatorname{Re} w \leq |\operatorname{Re} w| \leq |w|$ for every $w \in \mathbb{C}$ and that $|e^{-i\theta}| = 1$. \square

2.2. Complex contour integrals.

A continuous mapping $\gamma : [a, b] \rightarrow \mathbb{C}$ is called a *continuous curve in \mathbb{C}* with parameter interval $[a, b]$, but it is in fact more correct to say that γ is a *parameterization* of an *oriented continuous curve* in \mathbb{C} . If we look at $\delta : [0, 1] \rightarrow \mathbb{C}$ defined by $\delta(t) = \gamma(a + t(b - a))$, then γ and δ are different parameterizations of the same oriented continuous curve because when t moves from 0 to 1 then $a + t(b - a)$ moves from a to b and by assumption $\delta(t) = \gamma(a + t(b - a))$.

We say that two continuous mappings $\gamma : [a, b] \rightarrow \mathbb{C}$ and $\tau : [c, d] \rightarrow \mathbb{C}$ parameterize the same oriented continuous curve, if there exists a continuous and strictly increasing function φ of $[a, b]$ onto $[c, d]$ such that $\tau \circ \varphi = \gamma$. If we consider the variable t as time, different parameterizations just reflect the fact that we can move along the curve with different speed.

The points $\gamma(a)$ and $\gamma(b)$ are independent of the parameterization of the curve and are called the *starting point* and the *end point* respectively. The curve is called *closed* if $\gamma(a) = \gamma(b)$. The point set $\gamma([a, b])$ is also independent of the parameterization and is denoted γ^* . This is intuitively the “set of points on the curve”, where we do not focus on the orientation and the speed of moving along the curve.

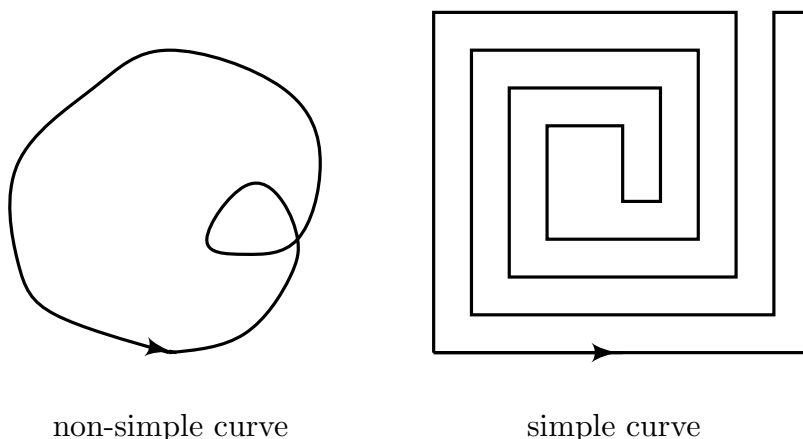

Figure 2.1

If $\gamma: [a, b] \rightarrow \mathbb{C}$ is a parameterization of an oriented continuous curve, then $t \mapsto \gamma(a + b - t)$ is a parameterization of the oppositely oriented curve called the *reverse curve*.

An oriented continuous curve $\gamma: [a, b] \rightarrow \mathbb{C}$ is called *simple*, if it does not intersect itself, i.e. if the restriction of γ to $[a, b[$ is one-to-one. For a simple closed curve γ as above we have of course $\gamma(a) = \gamma(b)$, but $x = a, y = b$ is the only pair of different parameter values (x, y) for which $\gamma(x) = \gamma(y)$.

A simple closed oriented continuous curve γ is called a *Jordan curve* because of *Jordan's theorem*:

A Jordan curve divides the plane \mathbb{C} in two domains: An “interior” bounded domain and an “exterior” unbounded domain. The curve is the common boundary of these two domains.

The result is intuitively obvious but surprisingly difficult to prove, so we will not give a proof. The result was given by C. Jordan in 1887. The first complete proof was given by O. Veblen in 1905.

A Jordan curve will normally be positively oriented, i.e. counterclockwise. This means that the interior domain is always to the left of the curve following the orientation.

The concept of an oriented continuous curve is the right one for topological questions, but it is too general for integration along the curve. For that we need the tangent vector of the curve, so we have to assume that the parameterization $\gamma: [a, b] \rightarrow \mathbb{C}$ is C^1 , i.e. continuously differentiable. We then speak about an oriented C^1 -curve or an oriented *smooth curve*. The derivative $\gamma'(t)$ represents the velocity-vector, which is parallel to the tangent at the point $\gamma(t)$. The number $|\gamma'(t)|$ is the *speed* at the point $\gamma(t)$.

Definition 2.2. Let $\gamma: [a, b] \rightarrow \mathbb{C}$ be an oriented C^1 -curve and let $f: \gamma^* \rightarrow \mathbb{C}$ be continuous. By the *contour (or path) integral of f along γ* we under-

stand the complex number

$$\int_{\gamma} f = \int_{\gamma} f(z) dz = \int_a^b f(\gamma(t)) \gamma'(t) dt.$$

Remark 2.3.

(i). The value of $\int_{\gamma} f$ is not changed if the parameterization γ is replaced by $\gamma \circ \varphi$, where $\varphi: [c, d] \rightarrow [a, b]$ is a bijective C^1 -function satisfying $\varphi'(t) > 0$ for all t . This follows from the formula for substitution in an integral.

(ii). Let $-\gamma$ denote the reverse curve of γ . Then

$$\int_{-\gamma} f = - \int_{\gamma} f.$$

(iii). Writing $f(z) = u(x, y) + iv(x, y)$, where $z = x + iy$ and $\gamma(t) = x(t) + iy(t)$, we see that

$$\begin{aligned} \int_{\gamma} f &= \int_a^b (u(x(t), y(t)) + iv(x(t), y(t))) (x'(t) + iy'(t)) dt \\ &= \int_a^b [u(x(t), y(t))x'(t) - v(x(t), y(t))y'(t)] dt \\ &\quad + i \int_a^b [v(x(t), y(t))x'(t) + u(x(t), y(t))y'(t)] dt. \end{aligned}$$

This shows that the real and imaginary part of the path integral are two ordinary tangential curve integrals, and the formula above can be rewritten

$$= \int_{\gamma} u dx - v dy + i \int_{\gamma} v dx + u dy = \int_{\gamma} (u, -v) \cdot ds + i \int_{\gamma} (v, u) \cdot ds.$$

Given two oriented continuous curves $\gamma: [a, b] \rightarrow \mathbb{C}$, $\delta: [c, d] \rightarrow \mathbb{C}$ such that $\gamma(b) = \delta(c)$, we can join the curves such that we first move along γ from $P = \gamma(a)$ to $Q = \gamma(b)$ and then along δ from $Q = \delta(c)$ to $R = \delta(d)$.

We denote this curve by $\gamma \cup \delta$, but in other treatments one can meet the notation $\gamma + \delta$. None of these notations matches the ordinary sense of the symbols \cup and $+$.

A parameterization of $\gamma \cup \delta$ defined on $[a, b + (d - c)]$ is given by

$$\tau(t) = \begin{cases} \gamma(t), & t \in [a, b] \\ \delta(t + c - b), & t \in [b, b + (d - c)]. \end{cases}$$

Assume now that γ, δ above are C^1 -parameterizations. Then τ is a piecewise C^1 -parameterization, because $\tau|_{[a, b]}$ is C^1 and $\tau|_{[b, b+d-c]}$ is C^1 , but the tangent vectors $\gamma'(b)$ and $\delta'(c)$ can be different.

It is natural to extend Definition 2.2 to the following

$$\int_{\tau} f = \int_{\gamma \cup \delta} f := \int_{\gamma} f + \int_{\delta} f.$$

Example 2.4. Let $f(z) = z^2$ and let $\gamma : [0, 1] \rightarrow \mathbb{C}$, $\delta : [1, 2] \rightarrow \mathbb{C}$ be the C^1 -curves $\gamma(t) = t^2 + it$, $\delta(t) = t + i$. Notice that γ passes from 0 to $1 + i$ along the parabola $y = \sqrt{x}$ and δ passes from $1 + i$ to $2 + i$ along a horizontal line, see Figure 2.2.

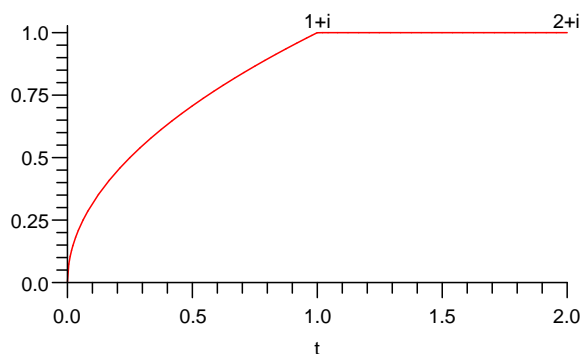

Figure 2.2

The composed curve $\gamma \cup \delta$ is given by the parameterization $\tau : [0, 2] \rightarrow \mathbb{C}$ defined by

$$\tau(t) = \begin{cases} t^2 + it, & t \in [0, 1] \\ t + i, & t \in [1, 2] \end{cases}, \quad \tau'(t) = \begin{cases} \gamma'(t) = 2t + i, & t \in [0, 1[\\ \delta'(t) = 1, & t \in]1, 2]. \end{cases}$$

Notice that $\gamma'(1) = 2 + i \neq \delta'(1) = 1$, hence τ' is not defined for $t = 1$. We find

$$\begin{aligned} \int_{\tau} f &= \int_{\gamma \cup \delta} f = \int_0^1 (t^2 + it)^2 (2t + i) dt + \int_1^2 (t + i)^2 dt \\ &= \int_0^1 (2t^5 + 5it^4 - 4t^3 - it^2) dt + \int_1^2 (t^2 + 2it - 1) dt \\ &= \left[\frac{1}{3}t^6 + it^5 - t^4 - \frac{i}{3}t^3 \right]_0^1 + \left[\frac{1}{3}t^3 + it^2 - t \right]_1^2 \\ &= \left(-\frac{2}{3} + \frac{2}{3}i \right) + \left(\frac{4}{3} + 3i \right) = \frac{2}{3} + \frac{11}{3}i. \end{aligned}$$

We will now formalize the above as the following extension of Definition 2.2.

Definition 2.5. By a *path* we understand a continuous parameterization $\gamma : [a, b] \rightarrow \mathbb{C}$ which is *piecewise* C^1 , i.e. there exists a partition $a = t_0 < t_1 < \dots < t_{n-1} < t_n = b$ such that

$$\gamma_j = \gamma \Big|_{[t_{j-1}, t_j]}, \quad j = 1, \dots, n$$

are C^1 -parameterizations, but there can be kinks at the points $\gamma(t_j)$, because the derivative from the right of γ_{j+1} at t_j can be different from the derivative from the left of γ_j at t_j . A *contour* is a closed path.

By the *integral of f along the path γ* we understand the complex number

$$\int_{\gamma} f = \int_{\gamma_1 \cup \dots \cup \gamma_n} f = \sum_{j=1}^n \int_{\gamma_j} f = \sum_{j=1}^n \int_{t_{j-1}}^{t_j} f(\gamma(t)) \gamma'(t) dt. \quad (1)$$

Remark 2.6. The function $f(\gamma(t))\gamma'(t)$, $t \in [a, b]$ is piecewise continuous, since it is continuous on each interval $]t_{j-1}, t_j[$ with limits at the end points. Therefore the function is Riemann integrable in the sense that its real and imaginary parts are Riemann integrable and (1) can be considered as a definition of the integral

$$\int_a^b f(\gamma(t)) \gamma'(t) dt.$$

Definition 2.7. By the *length* of a path $\gamma : [a, b] \rightarrow \mathbb{C}$, $\gamma(t) = x(t) + iy(t)$ as in Definition 2.5 we understand the number

$$L(\gamma) := \int_a^b |\gamma'(t)| dt = \int_a^b \sqrt{x'(t)^2 + y'(t)^2} dt,$$

using that the piecewise continuous function $|\gamma'(t)|$ is Riemann integrable.

In estimating the size of path integrals the following result is important:

The estimation lemma 2.8. Let $\gamma : [a, b] \rightarrow \mathbb{C}$ be a parameterization of a path as above. For a continuous function $f : \gamma^* \rightarrow \mathbb{C}$

$$\left| \int_{\gamma} f \right| \leq \max_{z \in \gamma^*} |f(z)| L(\gamma), \quad (2)$$

where $L(\gamma)$ is the length of the path.

Proof. It is enough to prove the result for a C^1 -parameterization, since it is easy to deduce the general result from there. By Theorem 2.1 we have

$$\begin{aligned} \left| \int_{\gamma} f \right| &= \left| \int_a^b f(\gamma(t)) \gamma'(t) dt \right| \leq \int_a^b |f(\gamma(t))| |\gamma'(t)| dt \\ &\leq \max_{t \in [a, b]} |f(\gamma(t))| \int_a^b |\gamma'(t)| dt = \max_{z \in \gamma^*} |f(z)| L(\gamma). \end{aligned}$$

□

Remark 2.9. In practice it is not necessary to determine

$$\max_{z \in \gamma^*} |f(z)| = \max_{t \in [a, b]} |f(\gamma(t))|,$$

because very often there is an easy estimate

$$|f(z)| \leq K \quad \forall z \in \gamma^*,$$

and hence $\max_{\gamma^*} |f| \leq K$. By (2) we then get

$$\left| \int_{\gamma} f \right| \leq K L(\gamma),$$

which in practice is just as useful as (2).

2.3. Primitives.

The concept of primitive or antiderivative as inverse operation of differentiation is known for functions on an interval. We shall now study the analogous concept for functions of a complex variable.

Definition 2.10. Let $f: G \rightarrow \mathbb{C}$ be defined in a domain $G \subseteq \mathbb{C}$. A function $F: G \rightarrow \mathbb{C}$ is called a *primitive* of f if F is holomorphic in G and $F' = f$.

If F is a primitive of f then so is $F + k$ for arbitrary $k \in \mathbb{C}$, and in this way we find all the primitives of f . In fact, if Φ is another primitive of f then $(\Phi - F)' = f - f = 0$, and therefore $\Phi - F$ is constant by Theorem 1.9.

A polynomial

$$p(z) = a_0 + a_1 z + \cdots + a_n z^n, \quad z \in \mathbb{C}$$

has primitives in \mathbb{C} namely the polynomials

$$P(z) = k + a_0 z + \frac{a_1}{2} z^2 + \cdots + \frac{a_n}{n+1} z^{n+1},$$

where $k \in \mathbb{C}$ is arbitrary. More generally, the sum of the power series

$$f(z) = \sum_{n=0}^{\infty} a_n (z - z_0)^n, \quad z \in K(z_0, \rho)$$

with radius of convergence ρ has the primitives

$$F(z) = k + \sum_{n=0}^{\infty} \frac{a_n}{n+1} (z - z_0)^{n+1}$$

in $K(z_0, \rho)$. This follows by Lemma 1.11 because F and f have the same radius of convergence.

Path integrals are easy to calculate if we know a primitive of the integrand.

Theorem 2.11. *Suppose that the continuous function $f: G \rightarrow \mathbb{C}$ in the domain $G \subseteq \mathbb{C}$ has a primitive $F: G \rightarrow \mathbb{C}$. Then*

$$\int_{\gamma} f(z) dz = F(z_2) - F(z_1)$$

for every path γ in G from z_1 to z_2 . In particular $\int_{\gamma} f = 0$ for every closed path γ .

Proof. For a path $\gamma: [a, b] \rightarrow G$ such that $\gamma(a) = z_1$, $\gamma(b) = z_2$ we find

$$\begin{aligned} \int_{\gamma} f(z) dz &= \int_a^b f(\gamma(t)) \gamma'(t) dt \\ &= \int_a^b \frac{d}{dt} F(\gamma(t)) dt = F(\gamma(b)) - F(\gamma(a)). \end{aligned}$$

□

For a continuous function f on an interval I we can determine a primitive by choosing $x_0 \in I$ and defining

$$F(x) = \int_{x_0}^x f(t) dt, \quad x \in I.$$

Looking for a primitive of $f: G \rightarrow \mathbb{C}$, we fix $z_0 \in G$ and try to define

$$F(z) = \int_{z_0}^z f(t) dt, \quad z \in G. \tag{1}$$

This integral shall be understood as an integral along a path from z_0 to z . As a first choice of path one would probably take the straight line from z_0 to

z , but then there is a risk of leaving the domain. There are infinitely many possibilities for drawing paths in G from z_0 to z , staircase lines and more complicated curves, see Figure 2.3.

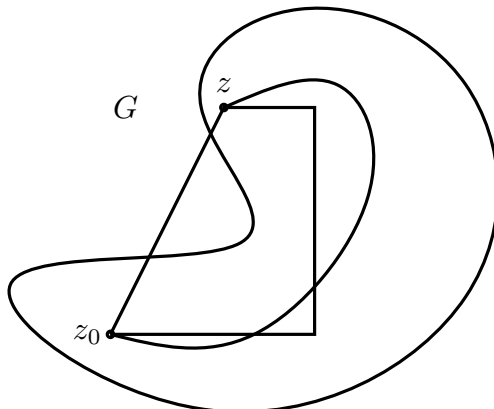

Figure 2.3

The question arises if the expression (1) is independent of the path from z_0 to z , because otherwise $F(z)$ is not well-defined by (1).

We shall now see how the above can be realized.

Lemma 2.12. *Let $f: G \rightarrow \mathbb{C}$ be a continuous function in a domain $G \subseteq \mathbb{C}$, and assume $\int_{\gamma} f = 0$ for every closed staircase line in G . Then f has a primitive in G .*

Proof. We choose $z_0 \in G$. For $z \in G$ we define $F(z) = \int_{\gamma_z} f$, where γ_z is chosen as a staircase line in G from z_0 to z . Such a choice is possible because G is a domain, and we claim that the path integral is independent of the choice of γ_z . In fact, if δ_z is another staircase line from z_0 to z then $\gamma := \delta_z \cup (-\gamma_z)$ is a closed staircase line and hence

$$0 = \int_{\gamma} f = \int_{\delta_z} f - \int_{\gamma_z} f.$$

In order to prove the differentiability of F at $z_1 \in G$ with $F'(z_1) = f(z_1)$, we fix $\varepsilon > 0$. Since f is continuous at z_1 there exists $r > 0$ such that $K(z_1, r) \subseteq G$ and

$$|f(z) - f(z_1)| \leq \varepsilon \text{ for } z \in K(z_1, r). \quad (2)$$

To $h = h_1 + ih_2$ such that $0 < |h| < r$ we consider the staircase line ℓ from z_1 to $z_1 + h$, first moving horizontally from z_1 to $z_1 + h_1$, and then moving vertically from $z_1 + h_1$ to $z_1 + h_1 + ih_2 = z_1 + h$. This path belongs to $K(z_1, r)$, hence to G . By joining ℓ to γ_{z_1} , we have a staircase line $\gamma_{z_1} \cup \ell$

from z_0 to $z_1 + h$, and we therefore get

$$F(z_1 + h) - F(z_1) = \int_{\gamma_{z_1} \cup \ell} f - \int_{\gamma_{z_1}} f = \int_{\ell} f.$$

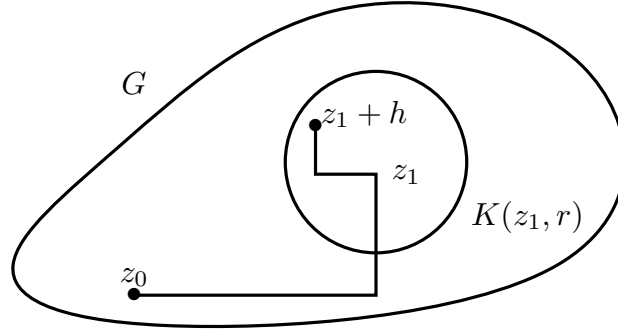

Figure 2.4

Since a constant c has the primitive cz , we have by Theorem 2.11

$$\int_{\ell} c = c(z_1 + h) - cz_1 = ch.$$

Putting $c = f(z_1)$ we get

$$\frac{1}{h} (F(z_1 + h) - F(z_1)) - f(z_1) = \frac{1}{h} \int_{\ell} f - f(z_1) = \frac{1}{h} \int_{\ell} (f(z) - f(z_1)) dz,$$

hence by the estimation Lemma 2.8, Remark 2.9 and (2)

$$\begin{aligned} \left| \frac{1}{h} (F(z_1 + h) - F(z_1)) - f(z_1) \right| &= \frac{1}{|h|} \left| \int_{\ell} (f(z) - f(z_1)) dz \right| \\ &\leq \frac{1}{|h|} \varepsilon L(\ell) = \frac{|h_1| + |h_2|}{|h|} \varepsilon \leq 2\varepsilon. \end{aligned}$$

□

Necessary and sufficient conditions for a continuous function to have a primitive are given next:

Theorem 2.13. *For a continuous function $f : G \rightarrow \mathbb{C}$ on a domain $G \subseteq \mathbb{C}$ the following conditions are equivalent:*

- (i) f has a primitive.
- (ii) For arbitrary $z_1, z_2 \in G$ the path integral $\int_{\gamma} f$ is independent of the path γ in G from z_1 to z_2 .
- (iii) $\int_{\gamma} f = 0$ for every closed path γ in G .

If the conditions are satisfied, we get a primitive F of f by choosing a point $z_0 \in G$ and by defining

$$F(z) = \int_{\gamma_z} f, \quad (3)$$

where γ_z is an arbitrary path in G from z_0 to z .

Proof. (i) \Rightarrow (ii) follows from Theorem 2.11.

(ii) \Rightarrow (iii): Let γ be a closed path in G from z_0 to z_0 and let $\delta(t) = z_0$, $t \in [0, 1]$ denote the constant path. By (ii) we have

$$\int_{\gamma} f = \int_{\delta} f = \int_0^1 f(\delta(t))\delta'(t)dt = 0.$$

(iii) \Rightarrow (i): We have in particular $\int_{\gamma} f = 0$ for every closed staircase line in G , so by Lemma 2.12 we know that f has a primitive $F(z) = \int_{\gamma_z} f$, where γ_z is chosen as a staircase line from a fixed point z_0 to z .

Finally using that the conditions (i) – (iii) are equivalent, we see that the expression (3) for F is independent of the choice of path (staircase line or not) from z_0 to z . \square

Example 2.14. Let C_r denote the circle $|z| = r$ traversed once following the positive orientation, i.e. $C_r(t) = re^{it}$, $t \in [0, 2\pi]$. For $n \in \mathbb{Z}$ we find

$$\int_{C_r} \frac{dz}{z^n} = \int_0^{2\pi} \frac{rie^{it}}{r^n e^{int}} dt = ir^{1-n} \int_0^{2\pi} e^{it(1-n)} dt = \begin{cases} 0, & n \neq 1, \\ 2\pi i, & n = 1, \end{cases}$$

where we have used that e^{itk}/ik is an ordinary primitive of e^{itk} , when k is a non-zero integer.

For $n \neq 1$ the result also follows because z^{-n} has the primitive $z^{1-n}/(1-n)$ in \mathbb{C} for $n \leq 0$, and in $\mathbb{C} \setminus \{0\}$ for $n \geq 2$. Since the value of the integral is $\neq 0$ for $n = 1$, we conclude that z^{-1} does not have a primitive in $\mathbb{C} \setminus \{0\}$.

Exercises for §2.

2.1. Find the value of the path integrals

$$\int_0^i \frac{dz}{(1-z)^2}, \int_i^{2i} \cos z \, dz \text{ and } \int_0^{i\pi} e^z \, dz.$$

(You are supposed to integrate along the line segment from the lower limit to the upper limit of the integral.)

Find next the value of the three integrals by determining primitives and using Theorem 2.11.

2.2. Find the value of $\int_{\gamma_n} \frac{dz}{z}$, where $\gamma_n : [0, 2\pi] \rightarrow \mathbb{C}$ is a parameterization of the unit circle traversed n times, $n \in \mathbb{Z} \setminus \{0\}$ and given by $\gamma_n(t) = e^{itn}$.

2.3. Prove that

$$\int_{\gamma} \frac{z}{(z^2 + 1)^2} dz = 0,$$

if γ is a closed path in $\mathbb{C} \setminus \{\pm i\}$.

2.4. Prove that

$$\int_{\gamma} P(z) dz = 0$$

for every polynomial P and every closed path γ in \mathbb{C} .

2.5. Prove that $A(\gamma) = \frac{1}{2i} \int_{\gamma} \bar{z} \, dz$ is a real number for every closed path γ in \mathbb{C} .

Hint. Writing $\gamma(t) = x(t) + iy(t)$, $t \in [a, b]$, prove that

$$A(\gamma) = \frac{1}{2} \int_a^b \begin{vmatrix} x(t) & y(t) \\ x'(t) & y'(t) \end{vmatrix} dt.$$

Determine $A(\gamma_n)$ for $\gamma_n(t) = e^{int}$, $t \in [0, 2\pi]$, $n = \pm 1$. For a simple closed path γ , explain that $A(\gamma)$ can be interpreted as the area bounded by γ counted positively or negatively in accordance with the orientation of γ .

2.6. Assume that f and g are holomorphic functions in a domain G and assume for convenience also that f' and g' are continuous (these assumptions will later be shown to be superfluous, see Theorem 4.8). Prove for any closed path γ in G :

$$\int_{\gamma} f'(z)g(z)dz = - \int_{\gamma} f(z)g'(z)dz.$$

§3. The theorems of Cauchy

The main result of this section is *Cauchy's integral theorem*: The integral of a holomorphic function along a closed path is zero provided the domain of definition is without holes.

From this result we deduce *Cauchy's integral formula*, expressing the value of a holomorphic function at an interior point of a disc in terms of the values on the circumference. The result is very surprising: Knowing just a tiny bit of a holomorphic function is enough to determine it in a much bigger set.

These two results are fundamental for the rest of the notes.

3.1. Cauchy's integral theorem.

We know that $f : G \rightarrow \mathbb{C}$ has a primitive provided the integral of f along every closed path is zero. We also know that continuity of $f : G \rightarrow \mathbb{C}$ is not enough (unlike real analysis) to secure the existence of a primitive. Even such a nice and elementary function as $f(z) = 1/z$ defined on $G = \mathbb{C} \setminus \{0\}$ does not have a primitive according to Example 2.14.

It turns out that for $f : G \rightarrow \mathbb{C}$ to have a primitive, we have to impose conditions on f as well as on the domain G . This is the fundamental discovery of Cauchy around 1825.

The requirement for G is roughly speaking that it does not contain holes. The domain $\mathbb{C} \setminus \{0\}$ has a hole at $\{0\}$. We will now make this intuitive way of speaking precise.

A domain $G \subseteq \mathbb{C}$ is called *simply connected* if for any two continuous curves γ_0, γ_1 in G having the same starting point a and the same end point b , it is possible to deform γ_0 continuously into γ_1 within G . Assuming that the two curves have $[0, 1]$ as common parameter interval, a *continuous deformation* means precisely that there exists a continuous function $H : [0, 1] \times [0, 1] \rightarrow G$, such that

$$H(0, t) = \gamma_0(t), \quad H(1, t) = \gamma_1(t) \text{ for } t \in [0, 1],$$

and

$$H(s, 0) = a, \quad H(s, 1) = b \text{ for } s \in [0, 1].$$

For every $s \in [0, 1]$ the parameterization $t \mapsto H(s, t)$ determines a continuous curve γ_s from a to b , and when s varies from 0 to 1 this curve varies from γ_0 to γ_1 . The function H is called a *homotopy*.

Intuitively, a simply connected domain is a *domain without holes*.

A subset G of \mathbb{C} is called *star-shaped* if there exists a point $a \in G$ such that for each $z \in G$ the line segment from a to z is contained in G . In a colourful way we can say that a light source at a is visible from each point z of G . We also say that G is star-shaped with respect to such a point a .

3.2

We mention without proof that a star-shaped domain is simply connected, cf. exc. 3.4.

A subset G of \mathbb{C} is called *convex* if for all $a, b \in G$ the line segment between a and b belongs to G , i.e. if

$$\gamma(t) = (1 - t)a + tb \in G \text{ for } t \in [0, 1].$$

A convex set is clearly star-shaped with respect to any of its points. Therefore a convex domain is simply connected.

Removing a half-line from \mathbb{C} leaves a domain which is star-shaped with respect to any point on the opposite half-line, see Example A of Figure 3.1.

An angular domain, i.e. the domain between two half-lines starting at the same point, is star-shaped. It is even convex if the angle is at most 180 degrees, but not convex if the angle is more than 180 degrees as in Example B (the grey part). The domain outside a parabola (Example C) is simply connected but not star-shaped. Removing one point from a domain (Example D) or removing one or more closed discs (Example E) leaves a domain which is not simply connected.

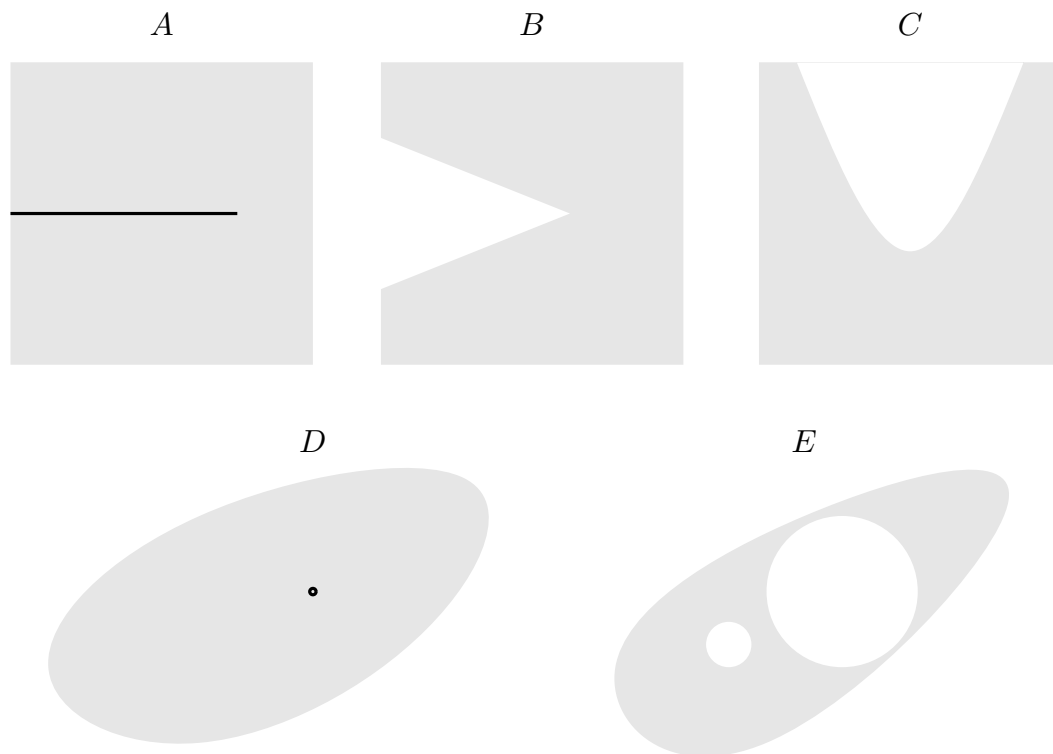

Figure 3.1

Theorem 3.1 (Cauchy's integral theorem). *Let $f : G \rightarrow \mathbb{C}$ be a holomorphic function in a simply connected domain $G \subseteq \mathbb{C}$ and let γ be a closed path in G . Then*

$$\int_{\gamma} f(z) dz = 0.$$

Cauchy gave the result in 1825. Cauchy worked with continuously differentiable functions f , i.e. f is assumed to be holomorphic and f' to be continuous.

For a differentiable function $f : I \rightarrow \mathbb{R}$ on an interval it can happen that f' has discontinuities. Here is an example with $I = \mathbb{R}$ and

$$f(x) = \begin{cases} x^2 \sin \frac{1}{x} & , x \neq 0 \\ 0 & , x = 0 \end{cases} \quad f'(x) = \begin{cases} 2x \sin \frac{1}{x} - \cos \frac{1}{x} & , x \neq 0 \\ 0 & , x = 0. \end{cases}$$

For a complex differentiable (holomorphic) function $f : G \rightarrow \mathbb{C}$ defined on an open set, it turns out most surprisingly that f' is continuous. This was discovered by the French mathematician E. Goursat in 1899. He gave a proof of Cauchy's integral theorem without assuming f' to be continuous. The main point in the proof is Goursat's Lemma below, but the proof that f' is continuous will first be given in Theorem 4.8.

Lemma 3.2 (Goursat's Lemma). *Let $G \subseteq \mathbb{C}$ be open and let $f \in \mathcal{H}(G)$. Then*

$$\int_{\partial\Delta} f(z) dz = 0$$

for every solid triangle $\Delta \subseteq G$ (meaning that all points bounded by the sides are contained in G).

Proof. The contour integral along the boundary $\partial\Delta$ of a triangle Δ shall be understood in the following sense: We move along the sides of the triangle following the positive orientation. Once we have proved that this integral is zero, the path integral using the negative orientation will of course also be zero.

We draw the segments between the midpoints of the sides of the triangle Δ , see Figure 3.2.⁴ Now Δ is divided in four triangles $\Delta^{(1)}, \dots, \Delta^{(4)}$ as shown on the figure, and we use the indicated orientations of the sides of the triangles. Using e.g. that the pair of triangles $(\Delta^{(1)}, \Delta^{(4)})$, $(\Delta^{(3)}, \Delta^{(4)})$, $(\Delta^{(4)}, \Delta^{(2)})$ have a common side with opposite orientations, we get

$$I = \int_{\partial\Delta} f = \sum_{i=1}^4 \int_{\partial\Delta^{(i)}} f.$$

⁴It is only for simplicity of drawing that the triangle is isosceles.

We claim that at least one of the four numbers $\int_{\partial\Delta^{(i)}} f$ must have an absolute value $\geq \frac{1}{4}|I|$, because otherwise we would get $|I| < |I|$ by the triangle inequality. Let one of the triangles with this property be denoted Δ_1 , hence

$$|I| \leq 4 \left| \int_{\partial\Delta_1} f \right|.$$

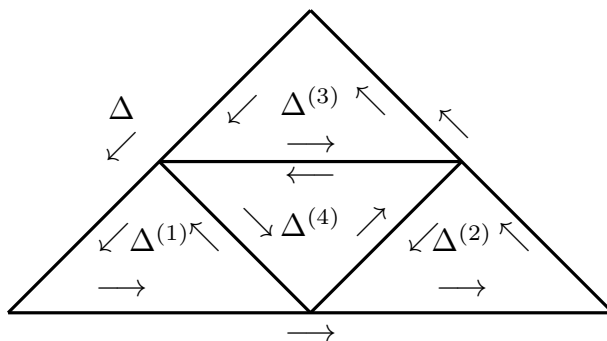

Figure 3.2

We now apply the same procedure to Δ_1 . Therefore, there exists a triangle Δ_2 , which is one of the four triangles in which Δ_1 is divided, such that

$$|I| \leq 4 \left| \int_{\partial\Delta_1} f \right| \leq 4^2 \left| \int_{\partial\Delta_2} f \right|.$$

Continuing in this way we get a decreasing sequence of closed triangles $\Delta \supset \Delta_1 \supset \Delta_2 \supset \dots$ such that

$$|I| \leq 4^n \left| \int_{\partial\Delta_n} f \right| \quad \text{for } n = 1, 2, \dots \quad (1)$$

We now have

$$\bigcap_{n=1}^{\infty} \Delta_n = \{z_0\}$$

for a uniquely determined point $z_0 \in \mathbb{C}$.

In fact, choosing $z_n \in \Delta_n$ for each n , the sequence (z_n) has a convergent subsequence with limit point z_0 by the Bolzano-Weierstrass theorem. It is easy to see that $z_0 \in \bigcap_1^{\infty} \Delta_n$, and since the sidelength of the triangles is divided by two in each step, there is only one number in the intersection.

If L denotes the length of $\partial\Delta$, then the length of $\partial\Delta_n$ equals $2^{-n}L$. We now use that f is differentiable at z_0 . If $\varepsilon > 0$ is fixed we can find $r > 0$ such that

$$|f(z) - f(z_0) - f'(z_0)(z - z_0)| \leq \varepsilon|z - z_0| \quad \text{for } z \in K(z_0, r) \subseteq G. \quad (2)$$

For $z \in \partial\Delta_n$ an elementary geometric consideration shows that $|z - z_0|$ is at most as large as half of the length of $\partial\Delta_n$ (look at Figure 3.3), hence

$$\max_{z \in \partial\Delta_n} |z - z_0| \leq \frac{1}{2} \cdot 2^{-n} L, \quad (3)$$

and the right-hand side is $< r$ for $n \geq N$ for a suitable natural number N . Therefore $\Delta_n \subseteq K(z_0, r)$ for $n \geq N$.

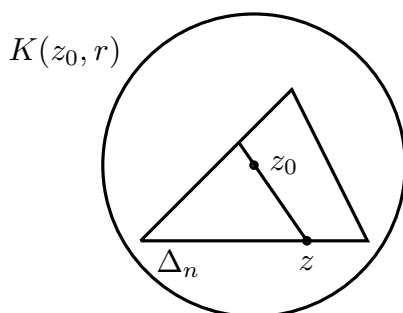

Figure 3.3

The function $z \mapsto f(z_0) + f'(z_0)(z - z_0)$ is a polynomial, hence possesses a primitive, so by Theorem 2.11 we have for any n

$$\int_{\partial\Delta_n} (f(z_0) + f'(z_0)(z - z_0)) dz = 0,$$

and hence

$$\int_{\partial\Delta_n} f(z) dz = \int_{\partial\Delta_n} (f(z) - f(z_0) - f'(z_0)(z - z_0)) dz.$$

By (2) and the estimation lemma we then get for $n \geq N$

$$\left| \int_{\partial\Delta_n} f(z) dz \right| \leq \varepsilon \cdot \max_{z \in \partial\Delta_n} |z - z_0| \cdot 2^{-n} L,$$

hence by (1) and (3)

$$|I| \leq 4^n \frac{\varepsilon}{2} (2^{-n} L)^2 = \frac{1}{2} \varepsilon L^2.$$

Since $\varepsilon > 0$ is arbitrary we get $I = 0$. □

Cauchy's integral theorem claims that the integral along any closed path is zero. We notice that it suffices to prove that $\int_{\gamma} f(z) dz = 0$ for all *closed*

staircase lines in G , because then f has a primitive in G by Lemma 2.12, and Theorem 2.11 next shows that $\int_{\gamma} f(z)dz = 0$ for arbitrary closed paths.

Goursat's Lemma tells us that $\int_{\partial\Delta} f(z)dz = 0$ for all solid triangles in G . Given an arbitrary closed staircase line in G , it is now quite obvious to try to draw extra line segments in order to split the staircase line in triangles and then use Goursat's Lemma for each of these triangles.

The problem is then to secure that all these extra line segments remain within G , and it is here we need the assumption that the domain is simply connected.

For an arbitrary simply connected domain this becomes quite technical, and we skip this proof.

We will give the complete proof for a star-shaped domain and this will suffice for all our applications in this course.

Theorem 3.3 (Cauchy's integral theorem for a star-shaped domain). *Let G be a star-shaped domain and assume that $f \in \mathcal{H}(G)$. Then*

$$\int_{\gamma} f(z)dz = 0$$

for every closed path γ in G .

Proof. Assume G to be star shaped with respect to $a \in G$ and let γ be a closed staircase line with vertices at $a_0, a_1, \dots, a_{n-1}, a_n = a_0$. As explained above it suffices to prove the assertion for this special path.

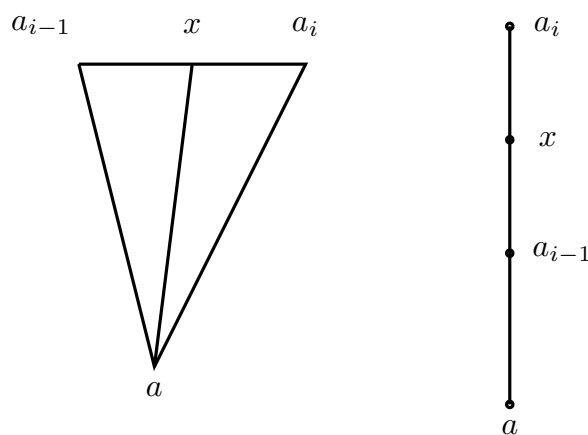

Figure 3.4

An arbitrary point x on the path belongs to one of the line segments from a_{i-1} to a_i , $i = 1, \dots, n$, and since G is star shaped with respect to a the line segment from a to x belongs to G . Therefore the solid triangle with vertices $\{a, a_{i-1}, a_i\}$ belongs to G . We now claim that the integral of f is 0 along the

path consisting of the following 3 segments: From a to a_{i-1} , from a_{i-1} to a_i and from a_i to a . In fact, either the 3 points form a non-degenerate triangle and the result follows from Goursat's lemma, or the 3 points lie on a line, and in this case the claim is elementary.

Summing these n vanishing integrals yields

$$\sum_{i=1}^n \int_{\partial\{a, a_{i-1}, a_i\}} f = 0.$$

Each line segment from a to a_i , $i = 1, \dots, n$, gives two contributions with opposite sign, so they cancel each other and what remains is $\int_{\gamma} f$, which consequently is 0. \square

Remark 3.4. Even if G is not simply connected, it may happen that $\int_{\gamma} f = 0$ for certain $f \in \mathcal{H}(G)$ and certain closed paths γ in G , e.g. in the following cases

- (a): f has a primitive in G
- (b): γ is a path in a simply connected sub-domain G_1 of G .

Notice that

$$\int_{\partial K(a,r)} \frac{dz}{z} = 0 \text{ for } a \neq 0, 0 < r < |a|.$$

Important notation Here and in the following we always use the short notation $\partial K(a, r)$ to indicate the path which traverses the circle counterclockwise. The function $1/z$ is holomorphic in $G = \mathbb{C} \setminus \{0\}$, which is a non simply connected domain, but the path is contained in a half-plane G_1 (make a drawing), and therefore the integral is 0.

Combining the Cauchy integral theorem (Theorem 3.1) and Theorem 2.13 we get:

Theorem 3.5. *Every holomorphic function in a simply connected domain has a primitive there.*

3.2. Cauchy's integral formula.

Let G be a domain, let $z_0 \in G$ and assume that $f \in \mathcal{H}(G \setminus \{z_0\})$. Suppose that we want to calculate the integral of f along a simple closed path C , traversed counterclockwise around the point z_0 .

As an application of Cauchy's integral theorem we shall see that it will be possible in many cases to replace C by another simple closed path K in G , likewise traversed counterclockwise around z_0 , i.e.

$$\int_C f(z) dz = \int_K f(z) dz. \quad (1)$$

The idea to prove such a result is to insert a number of cuts (line segments) from C to K (four at the figure), thereby creating a finite number of “small” closed paths γ_i , each of them consisting of 1) a part of C , 2) a cut, 3) a part of K with the opposite orientation, 4) a cut. We assume that it is possible to make the cuts in such a way that each γ_i is a closed path within a star-shaped sub-domain of $G \setminus \{z_0\}$, thereby proving that $\int_{\gamma_i} f = 0$. Since each cut will contribute with two integrals of opposite sign, we finally get

$$0 = \sum \int_{\gamma_i} f = \int_C f + \int_{-K} f,$$

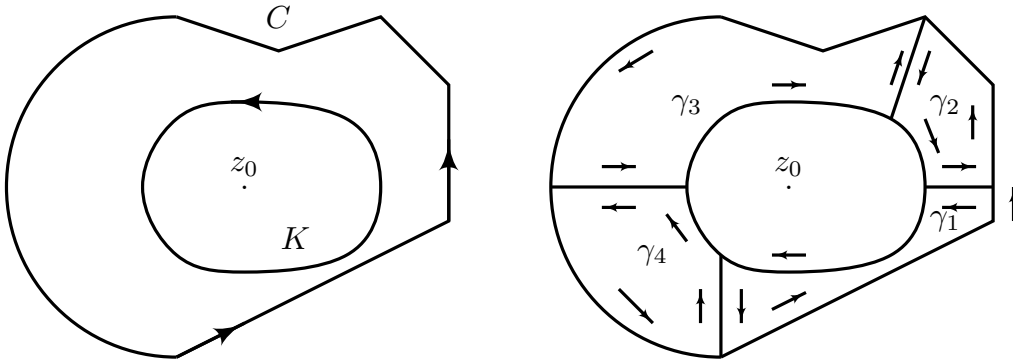

Figure 3.5

which shows the claim

$$\int_C f = \int_K f.$$

Before giving a concrete example of this principle, we need:

Lemma 3.6. *Let $G \subseteq \mathbb{C}$ be open and assume that $\overline{K(a, r)} \subseteq G$. Then there exists $R > r$ such that $K(a, R) \subseteq G$. (“There is always room for a larger disc”).*

Proof. If $G = \mathbb{C}$ every $R > r$ can be used. Assume next that $G \neq \mathbb{C}$, hence $\mathbb{C}G \neq \emptyset$, and define

$$R = \inf\{|z - a| \mid z \in \mathbb{C}G\}.$$

Then $K(a, R) \subseteq G$, and since $\overline{K(a, r)} \subseteq G$ by assumption we have $r \leq R$. We have to exclude the possibility $r = R$.

By Lemma A.1 in the Appendix with $K = \{a\}$, $F = \mathbb{C}G$ there exists $y' \in \mathbb{C}G$ such that $|a - y'| = R$. Assuming $r = R$ we get $y' \in \overline{K(a, r)}$, hence $y' \in G$, but this is a contradiction. \square

Example 3.7. Assume that $f \in \mathcal{H}(G \setminus \{z_0\})$ and that the paths C and K are the boundary circles of two discs $K(a, r)$ and $K(z_0, s)$ satisfying

$$\overline{K(z_0, s)} \subseteq K(a, r), \quad \overline{K(a, r)} \subseteq K(a, R) \subseteq G,$$

see Figure 3.6. We then have

$$\int_{\partial K(a, r)} f = \int_{\partial K(z_0, s)} f.$$

To prove this we insert 4 cuts between the circles using 2 orthogonal lines passing through z_0 . We observe that each of the 4 “small” closed paths belongs to a segment of $K(a, R)$. On figure 3.6 two of these segments are bounded by the dashed circle $K(a, R)$ and the dashed chord passing through z_0 . The northwestern and southeastern “small paths” are contained in these two segments. By rotating the dashed chord 90° around z_0 , we get segments containing the two remaining “small paths”. Each of the four segments is convex, and we have obtained what we wanted.

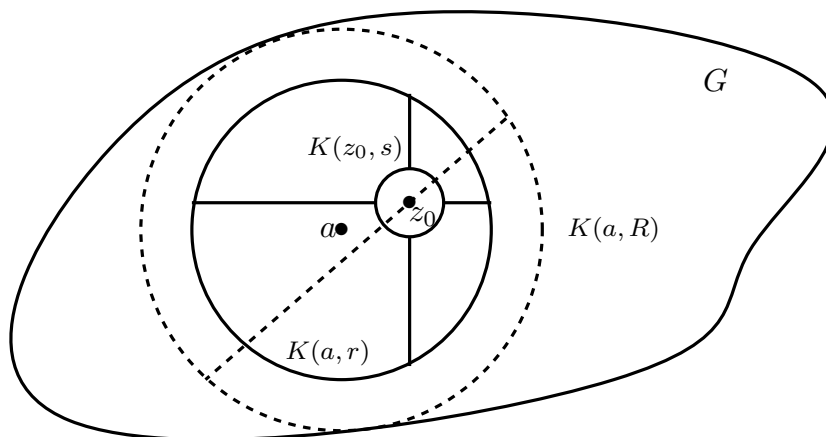

Figure 3.6

Theorem 3.8 (Cauchy’s integral formula). Let $f : G \rightarrow \mathbb{C}$ be holomorphic in an open set G and assume that $\overline{K(a, r)} \subseteq G$. For all $z_0 \in K(a, r)$

$$f(z_0) = \frac{1}{2\pi i} \int_{\partial K(a, r)} \frac{f(z)}{z - z_0} dz,$$

the circle being traversed once counter-clockwise.

Proof. Fix $z_0 \in K(a, r)$. By Example 3.7 applied to the holomorphic function

$$z \mapsto \frac{f(z)}{z - z_0}$$

in $G \setminus \{z_0\}$, we see that

$$\int_{\partial K(a,r)} \frac{f(z)}{z - z_0} dz = \int_{\partial K(z_0,s)} \frac{f(z)}{z - z_0} dz$$

for $0 < s < r - |a - z_0|$. Inserting the parameterization $\theta \mapsto z_0 + se^{i\theta}$, $\theta \in [0, 2\pi]$, of $\partial K(z_0, s)$ we find

$$\int_{\partial K(z_0,s)} \frac{dz}{z - z_0} = \int_0^{2\pi} \frac{sie^{i\theta}}{se^{i\theta}} d\theta = 2\pi i,$$

hence

$$I = \int_{\partial K(a,r)} \frac{f(z)}{z - z_0} dz - 2\pi i f(z_0) = \int_{\partial K(z_0,s)} \frac{f(z) - f(z_0)}{z - z_0} dz.$$

By the estimation lemma we then get

$$\begin{aligned} |I| &\leq \sup\left\{ \left| \frac{f(z) - f(z_0)}{z - z_0} \right| \mid |z - z_0| = s \right\} \cdot 2\pi s \\ &= 2\pi \sup\{|f(z) - f(z_0)| \mid |z - z_0| = s\}, \end{aligned}$$

but since f is continuous at z_0 , the given supremum approaches 0 for $s \rightarrow 0$, and we conclude that $I = 0$. \square

Corollary 3.9. *Let $f : G \rightarrow \mathbb{C}$ be holomorphic in an open set G and assume that $\overline{K(a, r)} \subseteq G$. Then*

$$f(a) = \frac{1}{2\pi} \int_0^{2\pi} f(a + re^{i\theta}) d\theta.$$

Proof. We apply the theorem for $z_0 = a$ and insert the parameterization

$$\theta \mapsto a + re^{i\theta}, \quad \theta \in [0, 2\pi].$$

\square

Cauchy's integral formula shows that knowledge of the values of a holomorphic function on a circle $\partial K(a, r)$ determines the values of the function in the disc. The Corollary tells us that the value at the centre of the circle is the mean value along the boundary.

Example 3.10. Cauchy's integral formula can be used to find the value of certain contour integrals:

$$\begin{aligned} \int_{\partial K(0,2)} \frac{\sin z}{1 + z^2} dz &= \frac{1}{2i} \int_{\partial K(0,2)} \frac{\sin z}{z - i} dz - \frac{1}{2i} \int_{\partial K(0,2)} \frac{\sin z}{z + i} dz \\ &= \pi \sin(i) - \pi \sin(-i) = 2\pi \sin(i) = \pi i \left(e - \frac{1}{e} \right). \end{aligned}$$

Example 3.11. Using Cauchy's integral theorem, we will prove the formula

$$\frac{1}{\sqrt{2\pi}} \int_{-\infty}^{\infty} e^{-\frac{1}{2}t^2} e^{itb} dt = e^{-\frac{1}{2}b^2}, \quad b \in \mathbb{R},$$

expressing that $e^{-\frac{1}{2}t^2}$ equals its Fourier transform up to a constant factor.

For $b = 0$ the formula reads

$$\frac{1}{\sqrt{2\pi}} \int_{-\infty}^{\infty} e^{-\frac{1}{2}t^2} dt = 1.$$

This we will not prove but consider as a well-known fact from probability theory about the normal or Gaussian density. Using that \cos is an even function and that \sin is odd, we find from Euler's formulas

$$\int_{-\infty}^{\infty} e^{-\frac{1}{2}t^2} e^{itb} dt = \int_{-\infty}^{\infty} e^{-\frac{1}{2}t^2} \cos(tb) dt,$$

showing that it is enough to prove the formula for $b > 0$.

Fixing $b > 0$, we integrate $f(z) = \exp(-\frac{1}{2}z^2)$ along the boundary of the rectangle of Figure 3.7. This integral is 0 by the Cauchy integral theorem because f is holomorphic in \mathbb{C} .

Parameterizations of the four sides of the rectangle are given as

$$\begin{aligned} \gamma_1(t) &= t, & t &\in [-a, a], \\ \gamma_2(t) &= a + it, & t &\in [0, b], \\ \gamma_3(t) &= -t + ib, & t &\in [-a, a], \\ \gamma_4(t) &= -a + i(b - t), & t &\in [0, b]; \end{aligned}$$

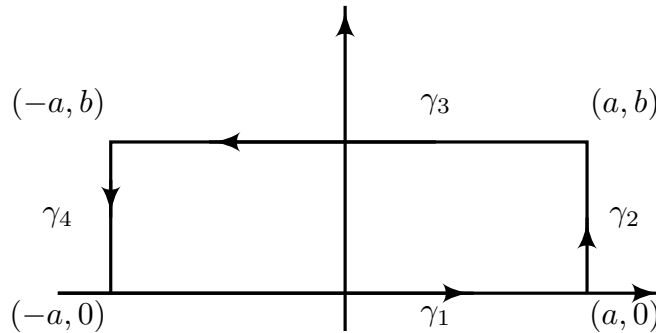

Figure 3.7

and we get

$$\begin{aligned} \int_{\gamma_1} f &= \int_{-a}^a e^{-\frac{1}{2}t^2} dt, & \int_{\gamma_3} f &= -e^{\frac{1}{2}b^2} \int_{-a}^a e^{-\frac{1}{2}t^2} e^{itb} dt, \\ \int_{\gamma_2} f &= ie^{-\frac{1}{2}a^2} \int_0^b e^{\frac{1}{2}t^2} e^{-iat} dt, & \int_{\gamma_4} f &= -ie^{-\frac{1}{2}a^2} \int_0^b e^{\frac{1}{2}(b-t)^2} e^{ia(b-t)} dt, \end{aligned}$$

hence

$$\left| \int_{\gamma_2} f \right|, \left| \int_{\gamma_4} f \right| \leq e^{-\frac{1}{2}a^2} b e^{\frac{1}{2}b^2} \rightarrow 0 \text{ for } a \rightarrow \infty.$$

Moreover,

$$\lim_{a \rightarrow \infty} \int_{\gamma_3} f = -e^{\frac{1}{2}b^2} \int_{-\infty}^{\infty} e^{-\frac{1}{2}t^2} e^{itb} dt,$$

and

$$\lim_{a \rightarrow \infty} \int_{\gamma_1} f = \int_{-\infty}^{\infty} e^{-\frac{1}{2}t^2} dt = \sqrt{2\pi},$$

so letting $a \rightarrow \infty$ in $\sum_{i=1}^4 \int_{\gamma_i} f = 0$, we get

$$\sqrt{2\pi} + 0 - e^{\frac{1}{2}b^2} \int_{-\infty}^{\infty} e^{-\frac{1}{2}t^2} e^{itb} dt + 0 = 0,$$

showing the formula.

Exercises for §3.

3.1. Determine the value of

$$\int_{\partial K(0,1)} \frac{dz}{(z-a)(z-b)},$$

when (i) $|a|, |b| < 1$, (ii) $|a| < 1, |b| > 1$, (iii) $|a|, |b| > 1$.

3.2. Calculate the contour integrals

$$\int_{\partial K(0,2)} \frac{e^z}{z-1} dz, \quad \int_{\partial K(0,2)} \frac{e^z}{\pi i - 2z} dz.$$

3.3. Prove that a convex domain $G \subseteq \mathbb{C}$ is simply connected.

3.4. Prove that a star-shaped domain $G \subseteq \mathbb{C}$ is simply connected.

Hint. Reduce the assertion to a domain G which is star-shaped with respect to 0.

For such a domain G let γ_0 be a continuous curve in G from $a \in G$ to $b \in G$ with parameter interval $[0, 1]$. Prove that the expression $H(s, t)$ defined by

$$H(s, t) = \begin{cases} (1-2t)a, & \text{for } t \in [0, \frac{1}{2}s], \\ (1-s)\gamma_0\left(\frac{t-\frac{1}{2}s}{1-s}\right), & \text{for } t \in [\frac{1}{2}s, 1-\frac{1}{2}s], \\ (2t-1)b, & \text{for } t \in [1-\frac{1}{2}s, 1], \end{cases}$$

is a homotopy, deforming γ_0 continuously to the curve

$$\gamma_1(t) = \begin{cases} (1-2t)a, & \text{for } t \in [0, \frac{1}{2}], \\ (2t-1)b, & \text{for } t \in [1-\frac{1}{2}, 1]; \end{cases}$$

and use this to finish the proof.

3.5. Let G be a domain which is star-shaped with respect to $z_0 \in G$. For every $z \in G$ let $[z_0, z]$ denote the line segment from z_0 to z with the parameterization $\gamma(t) = (1-t)z_0 + tz$.

Prove directly from Goursat's lemma that if $f \in \mathcal{H}(G)$ then $F : G \rightarrow \mathbb{C}$ defined by

$$F(z) = \int_{[z_0, z]} f$$

is a primitive of f satisfying $F(z_0) = 0$.

3.6. The domain $G = \mathbb{C} \setminus]-\infty, 0]$ is star-shaped with respect to 1. By exc. 3.5 the formula

$$L(z) = \int_{[1, z]} \frac{dw}{w}, \quad z \in G$$

defines a primitive of $1/z$ in G .

Writing $z = re^{i\theta}$, $\theta \in]-\pi, \pi[$, $r > 0$, show that

$$L(re^{i\theta}) = \log r + i\theta.$$

Hint. Use the path from 1 to r followed by the arc of circle from r til $re^{i\theta}$. (We prove in section 5 that $L(z) = \text{Log } z$, the principal logarithm of z .)

3.7. Let G be an open disc, let $a \in G$ and let b, c be different points on the boundary of the disc. Let U be the domain bounded by the line segments $[a, b]$, $[a, c]$ and one of the two arcs between b and c . Show that U is convex if the angle at a is $\leq \pi$. Show that U is star-shaped but not convex if the angle at a is $> \pi$. (U is a piece of tart).

Use such a domain U to show that 2 “small paths” are sufficient in Example 3.7.

3.8. Consider the domain

$$G = \mathbb{C} \setminus \{iy \mid y \in \mathbb{R}, |y| \geq 1\}$$

and prove that it is star-shaped with respect to 0. Define the function $\text{Arctan} : G \rightarrow \mathbb{C}$ by

$$\text{Arctan } z = \int_{[0, z]} \frac{dw}{1+w^2} = \int_0^1 \frac{zdt}{1+t^2z^2}, \quad z \in G.$$

In accordance with exc. 3.5 Arctan is holomorphic on G with the derivative

$$\frac{d}{dz} \text{Arctan } z = \frac{1}{1+z^2}.$$

Prove that $\text{Arctan}|_{\mathbb{R}}$ is the inverse function of $\tan :]-\frac{\pi}{2}, \frac{\pi}{2}[\rightarrow \mathbb{R}$.

(One can show that Arctan maps G bijectively onto the strip

$$\left\{ z = x + iy \mid -\frac{\pi}{2} < x < \frac{\pi}{2} \right\},$$

and is the inverse function of \tan restricted to that strip.)

Prove that

$$\text{Arctan } z = z - \frac{z^3}{3} + \frac{z^5}{5} - + \dots \quad \text{for } |z| < 1.$$

3.9. (Fresnel's integrals). Calculate the integrals

$$\int_0^\infty \sin(x^2) dx = \int_0^\infty \cos(x^2) dx = \frac{\sqrt{\pi}}{2\sqrt{2}},$$

which are to be understood as $\lim_{r \rightarrow \infty} \int_0^r$.

Hint. a) Use that $\int_{\gamma_r} \exp(iz^2) dz = 0$, where γ_r for $r > 0$ denotes the path along the boundary of the sector enclosed by the x -axis, the line $y = x$ and the arc re^{it} , $t \in [0, \frac{\pi}{4}]$.

b) Let $r \rightarrow \infty$ and use (example 3.11),

$$\lim_{r \rightarrow \infty} \int_0^r e^{-x^2} dx = \frac{1}{2}\sqrt{\pi}$$

as well as $\sin 2t \geq t$ for $t \in [0, \frac{\pi}{4}]$ (cf. c)) in order to prove the result.

c) Show that $\min\{\frac{\sin 2t}{t} \mid t \in]0, \frac{\pi}{4}]\} = \frac{4}{\pi} > 1$.

3.10. Consider the set $G = \mathbb{C} \setminus \mathbb{Z}$.

1) Show that G is a domain, i.e. that G is open and that any two points of G can be joined by a staircase line.

2) Is G convex?, star-shaped?, simply connected?

3) Show that

$$f(z) = 1/\sin(\pi z), \quad z \in G$$

is holomorphic in G .

4) Define $\gamma_T(t) = \frac{1}{2} + it$, $\delta_T(t) = \frac{3}{2} + it$, $t \in [-T, T]$.

Show that

$$\lim_{T \rightarrow \infty} \int_{\gamma_T} f(z) dz = i \int_{-\infty}^{\infty} \frac{dt}{\cosh(\pi t)}, \quad \lim_{T \rightarrow \infty} \int_{\delta_T} f(z) dz = -i \int_{-\infty}^{\infty} \frac{dt}{\cosh(\pi t)}$$

5) Define $\gamma_{T,a}(t) = a + it$, $t \in [-T, T]$, where $a \in \mathbb{R} \setminus \mathbb{Z}$. Show that

$$\varphi(a) := \lim_{T \rightarrow \infty} \int_{\gamma_{T,a}} f(z) dz$$

is constant in each of the intervals $]n, n+1[$, $n \in \mathbb{Z}$. (Notice that $\varphi(a)$ changes sign when a jumps from $]0, 1[$ to $]1, 2[$.)

Hint. For $n < a < b < n+1$ use the Cauchy integral theorem for the rectangle with corners $a \pm iT$, $b \pm iT$ and let $T \rightarrow \infty$.



Bernhard Riemann (1826–1866), German

§4. Applications of Cauchy's integral formula

In section 4.2 we shall apply the Cauchy integral formula to prove that a holomorphic function is differentiable infinitely often and is equal to the sum of its Taylor series. In the proof we need the concept of uniform convergence, which is treated in section 4.1. The set of holomorphic functions is stable with respect to local uniform convergence. This clearly makes it an important concept, which will be developed in section 4.4.

Liouville's theorem and the fundamental theorem of algebra appear unexpectedly.

4.1. Sequences of functions.

Let M be an arbitrary non-empty set. In the applications M will typically be a subset of \mathbb{C} .

A sequence of functions $f_n : M \rightarrow \mathbb{C}$ is said to *converge pointwise* to the function $f : M \rightarrow \mathbb{C}$ if for all $x \in M$

$$\lim_{n \rightarrow \infty} f_n(x) = f(x).$$

Using quantifiers this can be expressed:

$$\forall x \in M \forall \varepsilon > 0 \exists N \in \mathbb{N} \forall n \in \mathbb{N} (n \geq N \Rightarrow |f(x) - f_n(x)| \leq \varepsilon). \quad (1)$$

Examples: 1) Let $M = \mathbb{R}$ and $f_n(x) = |\sin x|^n$, $n = 1, 2, \dots$. Then

$$\lim_{n \rightarrow \infty} f_n(x) = \begin{cases} 1 & \text{for } x = \frac{\pi}{2} + p\pi, p \in \mathbb{Z} \\ 0 & \text{for } x \in \mathbb{R} \setminus \{\frac{\pi}{2} + \mathbb{Z}\pi\}, \end{cases}$$

i.e. $f_n : \mathbb{R} \rightarrow \mathbb{C}$ converges pointwise to the indicator function $f = 1_{\frac{\pi}{2} + \mathbb{Z}\pi}$ for the set $\frac{\pi}{2} + \mathbb{Z}\pi$, meaning the function which is 1 on the set and 0 on the complement of the set.

2) Let $M = \mathbb{C}$ and $f_n(z) = z^n/n!$, $n = 1, 2, \dots$. Then

$$\lim_{n \rightarrow \infty} f_n(z) = 0 \quad \text{for all } z \in \mathbb{C},$$

hence f_n converges pointwise to the zero function. In fact, the power series for \exp being convergent for all $z \in \mathbb{C}$, the n 'th term will converge to 0.

In both examples the functions f_n are continuous, but the limit function is not continuous in the first example.

What makes the limit function continuous in Example 2 but discontinuous in Example 1?

Fix $\varepsilon \in]0, 1[$ and $x \in \mathbb{R} \setminus \{\frac{\pi}{2} + \mathbb{Z}\pi\}$ and let us determine the smallest N such that $|\sin x|^N \leq \varepsilon$ and hence $|\sin x|^n \leq \varepsilon$ for $n \geq N$. We see that $N = N(x)$ is the smallest natural number $\geq \ln \varepsilon / \ln |\sin x|$ provided $x \notin \pi\mathbb{Z}$, and for $x \in \pi\mathbb{Z}$ we have $N(x) = 1$. The graph of the function $\ln \varepsilon / \ln |\sin x|$ for $x \in]0, \pi[$ is shown in Figure 4.1.

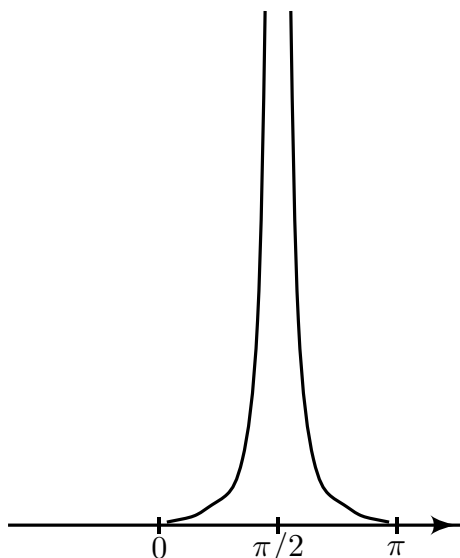

Figure 4.1

The graph approaches infinity when x approaches $\frac{\pi}{2}$, hence $N(x) \rightarrow \infty$ for $x \rightarrow \frac{\pi}{2}$. This means that we *can not* use the same N in (1) for all $x \in M$.

These observations motivate the following:

Definition 4.1. A sequence $f_n : M \rightarrow \mathbb{C}$ of functions is said to converge *uniformly* to the function $f : M \rightarrow \mathbb{C}$ if

$$\forall \varepsilon > 0 \exists N \in \mathbb{N} \forall n \in \mathbb{N} (n \geq N \Rightarrow |f(x) - f_n(x)| \leq \varepsilon \text{ for all } x \in M). \quad (2)$$

Using that

$$|f(x) - f_n(x)| \leq \varepsilon \text{ for all } x \in M \Leftrightarrow \sup\{|f(x) - f_n(x)| \mid x \in M\} \leq \varepsilon,$$

the uniform convergence is equivalent to

$$\lim_{n \rightarrow \infty} \sup\{|f(x) - f_n(x)| \mid x \in M\} = 0.$$

The functions $f_n(z) = z^n/n!$ converge uniformly to the zero function for z belonging to a *bounded set* $M \subseteq \mathbb{C}$. The boundedness of M just means that there exists a constant K such that $|z| \leq K$ for $z \in M$, and hence

$$\sup\{|f_n(z) - 0| \mid z \in M\} \leq \frac{K^n}{n!} \rightarrow 0.$$

On the other hand, f_n *does not* converge to the zero function uniformly for $z \in \mathbb{C}$ because

$$\sup\{|f_n(z) - 0| \mid z \in \mathbb{C}\} = \infty \text{ for all } n.$$

The relevance of uniform convergence for our discussion is proved in the next theorem.

Theorem 4.2. *Let $M \subseteq \mathbb{C}$ and let $f_n : M \rightarrow \mathbb{C}$ be uniformly convergent to the function $f : M \rightarrow \mathbb{C}$.*

If all the functions f_n are continuous at $z_0 \in M$, then so is f .

Proof. Fix $\varepsilon > 0$. We shall determine $\delta > 0$ such that

$$\forall z \in M \quad (|z - z_0| < \delta \Rightarrow |f(z) - f(z_0)| < \varepsilon).$$

Since $\sup\{|f(z) - f_n(z)| \mid z \in M\} \rightarrow 0$ for $n \rightarrow \infty$, there exists N such that

$$\sup\{|f(z) - f_n(z)| \mid z \in M\} < \varepsilon/3 \text{ for } n \geq N$$

in particular

$$\forall z \in M : |f(z) - f_N(z)| < \varepsilon/3. \quad (3)$$

By the continuity of f_N at z_0 there exists $\delta > 0$ such that

$$\forall z \in M \left(|z - z_0| < \delta \Rightarrow |f_N(z) - f_N(z_0)| < \frac{\varepsilon}{3} \right). \quad (4)$$

For $z \in M$ such that $|z - z_0| < \delta$ we then get

$$\begin{aligned} |f(z) - f(z_0)| &= |(f(z) - f_N(z)) + (f_N(z) - f_N(z_0)) + (f_N(z_0) - f(z_0))| \\ &\leq |f(z) - f_N(z)| + |f_N(z) - f_N(z_0)| + |f_N(z_0) - f(z_0)| \\ &< \varepsilon/3 \qquad \qquad + \varepsilon/3 \qquad \qquad + \varepsilon/3 = \varepsilon. \end{aligned}$$

□

(In Theorem 4.2 M could just as well be a subset of \mathbb{R}^n or a metric space.)

Definition 4.3. An infinite series $\sum_0^\infty f_n(x)$ of functions $f_n : M \rightarrow \mathbb{C}$ is said to converge *uniformly* to the sum function $s : M \rightarrow \mathbb{C}$ if the sequence of partial sums

$$s_n(x) = \sum_{k=0}^n f_k(x), \quad x \in M$$

converges uniformly to s .

Theorem 4.4. Weierstrass' M-test. Let $\sum_0^\infty f_n(x)$ be an infinite series of functions $f_n : M \rightarrow \mathbb{C}$ and assume that there exists a convergent series $\sum_0^\infty a_n$ having positive terms a_n such that

$$\forall n \in \mathbb{N}_0 \quad \forall x \in M : |f_n(x)| \leq a_n,$$

i.e. a_n is a majorant for f_n on M for each n . Then the series $\sum_0^\infty f_n(x)$ converges uniformly on M .

Proof. The comparison test shows that the series $\sum_0^\infty f_n(x)$ is absolutely convergent for every $x \in M$. Denoting the sum function $s : M \rightarrow \mathbb{C}$, the n 'th partial sum s_n satisfies

$$s(x) - s_n(x) = \sum_{k=n+1}^{\infty} f_k(x),$$

hence

$$|s(x) - s_n(x)| = \left| \sum_{k=n+1}^{\infty} f_k(x) \right| \leq \sum_{k=n+1}^{\infty} |f_k(x)| \leq \sum_{k=n+1}^{\infty} a_k$$

showing that

$$\sup\{|s(x) - s_n(x)| \mid x \in M\} \leq \sum_{k=n+1}^{\infty} a_k.$$

Since $\sum_0^\infty a_k < \infty$, the tail lemma asserts that $\sum_{k=n+1}^{\infty} a_k \rightarrow 0$ for $n \rightarrow \infty$, hence $s_n(x) \rightarrow s(x)$ uniformly on M . \square

Theorem 4.5. A power series $\sum_0^\infty a_n z^n$ having positive radius of convergence ρ and sum function

$$f(z) = \sum_{n=0}^{\infty} a_n z^n, \quad z \in K(0, \rho)$$

converges uniformly to f on every closed disc $\overline{K(0, r)}$, where $r < \rho$.

(The convergence need not be uniform on $K(0, \rho)$. The reader is supposed to be able to distinguish between the two assertions mentioned).

Proof. The result is an immediate consequence of Theorem 4.4 because $\sum_0^\infty |a_n| r^n$ is a convergent series, the general term of which majorizes $a_n z^n$ on $K(0, r)$. \square

We can now add a simple rule about path integrals to the rules of §2.2.

Theorem 4.6. *Let $\gamma : [a, b] \rightarrow \mathbb{C}$ be a path in \mathbb{C} and let $f_n : \gamma^* \rightarrow \mathbb{C}$ be a sequence of continuous functions.*

(i) *If $f_n \rightarrow f$ uniformly on γ^* , then*

$$\lim_{n \rightarrow \infty} \int_{\gamma} f_n = \int_{\gamma} f \quad \left(= \int_{\gamma} \lim_{n \rightarrow \infty} f_n \right).$$

(ii) *If $\sum_{n=0}^{\infty} f_n$ converges uniformly on γ^* to the sum function $s : \gamma^* \rightarrow \mathbb{C}$, then*

$$\sum_{n=0}^{\infty} \int_{\gamma} f_n = \int_{\gamma} s \quad \left(= \int_{\gamma} \sum_{n=0}^{\infty} f_n \right).$$

Proof. (i): Notice that f is continuous on γ^* because of Theorem 4.2. Fix $\varepsilon > 0$. By assumption there exists $N \in \mathbb{N}$ such that for $n \geq N$ and $z \in \gamma^*$

$$|f(z) - f_n(z)| \leq \varepsilon,$$

hence by the estimation lemma 2.8

$$\left| \int_{\gamma} f - \int_{\gamma} f_n \right| = \left| \int_{\gamma} (f - f_n) \right| \leq \varepsilon L(\gamma),$$

proving the assertion.

(ii): Since $s_n = \sum_{k=0}^n f_k$ converges to s uniformly on γ^* , we get by (i) that $\int_{\gamma} s_n \rightarrow \int_{\gamma} s$, but since

$$\int_{\gamma} s_n = \sum_{k=0}^n \int_{\gamma} f_k,$$

the assertion follows. \square

Remark 4.7. Here are two simple observations about uniform convergence.

(i) If a sequence of functions $f_n : M \rightarrow \mathbb{C}$ converges uniformly to $f : M \rightarrow \mathbb{C}$, then the sequence of restrictions $f_n|_A$ to an arbitrary subset $A \subseteq M$ converges uniformly to $f|_A$.

(ii) Assume that $f_n : M \rightarrow \mathbb{C}$ converges pointwise to $f : M \rightarrow \mathbb{C}$ and assume that $A, B \subseteq M$.

If $f_n|_A$ converges uniformly to $f|_A$ and $f_n|_B$ converges uniformly to $f|_B$, then $f_n|_{A \cup B}$ converges uniformly to $f|_{A \cup B}$.

Only the proof for (ii) requires a comment. Fixing $\varepsilon > 0$, the assumptions about uniform convergence on A and on B makes it possible to find $N_A \in \mathbb{N}$, $N_B \in \mathbb{N}$ such that for $n \in \mathbb{N}$

$$n \geq N_A \Rightarrow |f(x) - f_n(x)| \leq \varepsilon \text{ for all } x \in A$$

and

$$n \geq N_B \Rightarrow |f(x) - f_n(x)| \leq \varepsilon \text{ for all } x \in B.$$

For $n \geq \max(N_A, N_B)$ we then have

$$|f(x) - f_n(x)| \leq \varepsilon \text{ for all } x \in A \cup B,$$

proving the uniform convergence on $A \cup B$.

4.2. Expansion of holomorphic functions in power series.

Let $G \subseteq \mathbb{C}$ be an open set. If $G \neq \mathbb{C}$ and $a \in G$ is arbitrary, there exists a largest open disc $K(a, \rho)$ contained in G . Its radius is given by

$$\rho = \inf \{|a - z| \mid z \in \mathbb{C} \setminus G\}.$$

If $G = \mathbb{C}$ we define $K(a, \infty) = \mathbb{C}$, and also in this case we speak about the largest open disc contained in G .

Using the Cauchy integral formula we shall now show that $f \in \mathcal{H}(G)$ is differentiable infinitely often. For $a \in G$ the power series $\sum_{n=0}^{\infty} \frac{f^{(n)}(a)}{n!} (z-a)^n$ is called the *Taylor series* of f with centre a .

Theorem 4.8. *Let $f \in \mathcal{H}(G)$. Then f is differentiable infinitely often and the Taylor series with centre $a \in G$ is convergent with sum f in the largest open disc $K(a, \rho) \subseteq G$:*

$$f(z) = \sum_{n=0}^{\infty} \frac{f^{(n)}(a)}{n!} (z-a)^n \quad \text{for } z \in K(a, \rho). \quad (1)$$

Assume that $\overline{K(a, r)} \subseteq G$. For arbitrary $z_0 \in K(a, r)$ we have

$$f^{(n)}(z_0) = \frac{n!}{2\pi i} \int_{\partial K(a, r)} \frac{f(z)}{(z-z_0)^{n+1}} dz, \quad n = 0, 1, \dots, \quad (2)$$

which is called *Cauchy's integral formula for the n 'th derivative*.

Proof. The function $z \mapsto f(z)/(z-a)^{n+1}$ being holomorphic in $G \setminus \{a\}$, it follows by Example 3.7 that the numbers

$$a_n(r) = \frac{1}{2\pi i} \int_{\partial K(a,r)} \frac{f(z) dz}{(z-a)^{n+1}}$$

are independent of r for $0 < r < \rho$. We therefore denote them briefly a_n , $n = 0, 1, \dots$

Fixing $z_0 \in K(a, \rho)$ and next choosing $r > 0$ such that $|z_0 - a| < r < \rho$, we get by Cauchy's integral formula

$$f(z_0) = \frac{1}{2\pi i} \int_{\partial K(a,r)} \frac{f(z)}{z - z_0} dz.$$

We will prove the series expansion (1) by writing $\frac{1}{z-z_0}$ as a sum of a convergent series, insert this in the above integral formula and finally interchange summation and integration.

First notice that for $z \in \partial K(a, r)$

$$\frac{1}{z - z_0} = \frac{1}{z - a + a - z_0} = \frac{1}{z - a} \frac{1}{1 - (z_0 - a)/(z - a)},$$

and moreover $|(z_0 - a)/(z - a)| = |z_0 - a|/r < 1$, which makes it possible to write the last fraction as the sum of a geometric series, hence

$$\frac{1}{z - z_0} = \frac{1}{z - a} \sum_{n=0}^{\infty} \left(\frac{z_0 - a}{z - a} \right)^n.$$

This shows that

$$\frac{f(z)}{z - z_0} = \sum_{n=0}^{\infty} g_n(z), \tag{3}$$

where

$$g_n(z) = \frac{f(z)(z_0 - a)^n}{(z - a)^{n+1}}.$$

Using that $\partial K(a, r)$ is closed and bounded, we have $M = \sup\{|f(z)| \mid z \in \partial K(a, r)\} < \infty$. The infinite series $\sum_0^{\infty} g_n(z)$ converges uniformly for $z \in \partial K(a, r)$ by Weierstrass' M-test because of the majorization

$$|g_n(z)| \leq \frac{M}{r} \left(\frac{|z_0 - a|}{r} \right)^n, \quad \sum_0^{\infty} \left(\frac{|z_0 - a|}{r} \right)^n < \infty.$$

By Theorem 4.6 (ii) it is allowed to integrate term by term in (3), hence

$$\begin{aligned} f(z_0) &= \frac{1}{2\pi i} \int_{\partial K(a,r)} \frac{f(z)}{z - z_0} dz \\ &= \sum_{n=0}^{\infty} \frac{1}{2\pi i} \int_{\partial K(a,r)} g_n(z) dz = \sum_{n=0}^{\infty} a_n (z_0 - a)^n. \end{aligned}$$

This shows that the power series $\sum_{n=0}^{\infty} a_n (z - a)^n$ is convergent with sum $f(z)$ for all $z \in K(a, \rho)$. Setting $g(z) = f(z + a)$ we have $g(z) = \sum_{n=0}^{\infty} a_n z^n$ for $z \in K(0, \rho)$. By §1.4 we know that $g(z)$ is differentiable infinitely often in $K(0, \rho)$, hence so is $f(z)$ for $z \in K(a, \rho)$. Using that the coefficients in the power series $g(z) = \sum_{n=0}^{\infty} a_n z^n$ are given by $a_n = g^{(n)}(0)/n!$ (cf. §1.4), we find $a_n = f^{(n)}(a)/n!$, thereby showing (1). The formula for $a_n = a_n(r)$, from the beginning of the proof, next shows that

$$f^{(n)}(a) = \frac{n!}{2\pi i} \int_{\partial K(a,r)} \frac{f(z)}{(z - a)^{n+1}} dz, \quad 0 < r < \rho. \quad (4)$$

Suppose now $z_0 \in K(a, r)$, $\overline{K(a, r)} \subseteq G$. If $0 < s < r - |z_0 - a|$ then $\overline{K(z_0, s)} \subseteq K(a, r)$, so (4) with a replaced by z_0 and r by s gives

$$f^{(n)}(z_0) = \frac{n!}{2\pi i} \int_{\partial K(z_0,s)} \frac{f(z)}{(z - z_0)^{n+1}} dz = \frac{n!}{2\pi i} \int_{\partial K(a,r)} \frac{f(z)}{(z - z_0)^{n+1}} dz,$$

where the last equality follows from Example 3.7. This shows (2). \square

Remark 4.9.

(i) To help memorizing the formulas observe that Cauchy's integral formula for the derivative follows formally from Cauchy's integral formula by derivation under the integral sign. This idea can be rigorously developed to another proof of Theorem 4.8.

(ii) A function $f : G \rightarrow \mathbb{C}$ in a domain $G \subseteq \mathbb{C}$ is called (*complex*) *analytic* if for every $a \in G$ there exists a power series $\sum_0^{\infty} a_n (z - a)^n$ with sum $f(z)$ in a suitable disc $K(a, r) \subseteq G$, where r is allowed to vary with a . By §1.4 an analytic function is holomorphic, and Theorem 4.8 shows that a holomorphic function is analytic. Moreover, the power series attached to the point a is the Taylor series. The two concepts "analytic" and "holomorphic" are thus equivalent. K. Weierstrass (1815–1897) gave the first rigorous treatment of complex function theory based on the concept of an analytic function.

(iii) Since f' is again holomorphic, we have proved that f' is in particular a continuous function, cf. the preamble to Goursat's lemma.

(iv) The radius of convergence R for the power series in (1) is $\geq \rho$. It can happen that $R > \rho$. See Theorem 6.24 for a case where $R = \rho$.

4.3. Harmonic functions.

Consider two differentiable functions $u, v : G \rightarrow \mathbb{R}$ satisfying the Cauchy-Riemann differential equations in the open set $G \subseteq \mathbb{R}^2$

$$\frac{\partial u}{\partial x} = \frac{\partial v}{\partial y}, \quad \frac{\partial u}{\partial y} = -\frac{\partial v}{\partial x} \quad \text{in } G.$$

Using that $f = u + iv$ is holomorphic and hence differentiable infinitely often, we see the very surprising phenomenon that u, v are *automatically* C^∞ -functions in G . Differentiating once more we find

$$\frac{\partial^2 u}{\partial x^2} = \frac{\partial^2 v}{\partial x \partial y}, \quad \frac{\partial^2 u}{\partial y^2} = -\frac{\partial^2 v}{\partial y \partial x}$$

hence $\frac{\partial^2 u}{\partial x^2} + \frac{\partial^2 u}{\partial y^2} = 0$ because $\frac{\partial^2 v}{\partial x \partial y} = \frac{\partial^2 v}{\partial y \partial x}$.

In an analogous way we see that $\frac{\partial^2 v}{\partial x^2} + \frac{\partial^2 v}{\partial y^2} = 0$.

The expression $\frac{\partial^2}{\partial x^2} + \frac{\partial^2}{\partial y^2}$ is called *the Laplace operator* and is usually written Δ , i.e. $\Delta \varphi = \frac{\partial^2 \varphi}{\partial x^2} + \frac{\partial^2 \varphi}{\partial y^2}$.

A real-valued C^2 -function φ defined on an open set $G \subseteq \mathbb{R}^2$ is called *harmonic* in G , if $\Delta \varphi = 0$ in G . We have thus proved: *The real part and the imaginary part of a holomorphic function are harmonic.*

The opposite is true locally. More precisely we will prove:

Theorem 4.10. *Let u be a harmonic function in a simply connected domain $G \subseteq \mathbb{R}^2 \approx \mathbb{C}$. Then there exists a holomorphic function $f : G \rightarrow \mathbb{C}$ such that $\operatorname{Re} f = u$, and f is uniquely determined up to addition of a purely imaginary constant.*

Proof. The function $g(z) = \frac{\partial u}{\partial x} - i \frac{\partial u}{\partial y}$ is holomorphic in G , because we can verify the Cauchy-Riemann equations:

$$\frac{\partial^2 u}{\partial x^2} = -\frac{\partial^2 u}{\partial y^2}, \quad \frac{\partial^2 u}{\partial y \partial x} = \frac{\partial^2 u}{\partial x \partial y}.$$

By Theorem 3.5 there exists a primitive $h \in \mathcal{H}(G)$ to g , i.e. $h' = g$ (here we have used that G is simply connected). Moreover

$$h' = \frac{\partial}{\partial x}(\operatorname{Re} h) + i \frac{\partial}{\partial x}(\operatorname{Im} h) = \frac{\partial}{\partial x}(\operatorname{Re} h) - i \frac{\partial}{\partial y}(\operatorname{Re} h),$$

and we therefore get

$$\frac{\partial}{\partial x}(\operatorname{Re} h) = \frac{\partial u}{\partial x}, \quad \frac{\partial}{\partial y}(\operatorname{Re} h) = \frac{\partial u}{\partial y},$$

showing that $u - \operatorname{Re} h$ is a real constant, which we call c . Then $f = h + c$ is a holomorphic function having u as its real part. If f and f_1 are holomorphic functions such that $\operatorname{Re} f = \operatorname{Re} f_1 = u$, then $i(f - f_1)$ is a real-valued holomorphic function, hence constant by Corollary 1.10. \square

Given a harmonic function u in a simply connected domain $G \subseteq \mathbb{R}^2$, there exists, as we have seen, another harmonic function v in G such that $f = u + iv$ is holomorphic. The function v is only determined up to addition of a constant. We call v a *conjugate harmonic function* to u . As an example the functions $u(x, y) = x$ and $v(x, y) = y$ are harmonic in \mathbb{R}^2 and v is conjugate to u because $z = u + iv$ is holomorphic. Also x and $y + c$ are conjugate harmonic functions for any real c .

If u is harmonic in an open set G , then for any disc $K(a, r) \subseteq G$ there exists a conjugate harmonic function v to u in the disc because it is simply connected. Using that $u + iv$ is holomorphic in $K(a, r)$, we see that $u \in C^\infty(G)$.

We thus have the remarkable result: *Suppose that $u \in C^2(G)$ satisfies $\Delta u = 0$. Then $u \in C^\infty(G)$.*

This result is a real-valued counterpart to the complex analysis result that a holomorphic function is differentiable infinitely often.

4.4. Morera's theorem and local uniform convergence.

In real analysis we know that every continuous function on an interval has a primitive. In complex function theory the situation is completely different:

Theorem 4.11. *If a function $f : G \rightarrow \mathbb{C}$ on an open set $G \subseteq \mathbb{C}$ has a primitive, then it is holomorphic.*

Proof. If $F \in \mathcal{H}(G)$ is a primitive of f , then also $f = F'$ is holomorphic by Theorem 4.8. \square

We recall that a holomorphic function in a domain G need not have a primitive in G , (Example 2.14, $f(z) = z^{-1}$ in $\mathbb{C} \setminus \{0\}$), but if G is assumed to be simply connected a primitive always exists, cf. Theorem 3.5.

The following theorem from 1886 by the Italian mathematician G. Morera is a converse to the integral theorem of Cauchy. Notice that the domain of definition need not be simply connected but can be any open set.

Theorem 4.12. Morera's theorem. *Let $f : G \rightarrow \mathbb{C}$ be continuous in an open set $G \subseteq \mathbb{C}$. If $\int_{\gamma} f = 0$ for every closed path γ in G , or if only $\int_{\partial\Delta} f = 0$ for every solid triangle $\Delta \subseteq G$, then f is holomorphic in G .*

Proof. Fix $a \in G$. It is enough to prove that f is holomorphic in the largest open disc $K(a, \rho)$, contained in G . For a solid triangle Δ contained in $K(a, \rho)$ we get by assumption $\int_{\partial\Delta} f = 0$, and as in the proof of Cauchy's integral theorem for a star-shaped domain we conclude that the integral of f along every closed staircase line in $K(a, \rho)$ equals 0, hence f has a primitive in $K(a, \rho)$. By Theorem 4.11 we now get that f is holomorphic in $K(a, \rho)$. \square

We shall now recall a fundamental result in mathematical analysis and topology.

Theorem 4.13. Borel's covering theorem. *Let K be a closed and bounded subset of \mathbb{C} .*

To every family $(G_i)_{i \in I}$ of open sets in \mathbb{C} covering K , i.e.

$$K \subseteq \bigcup_{i \in I} G_i,$$

there exist finitely many indices $i_1, \dots, i_n \in I$ such that

$$K \subseteq G_{i_1} \cup \dots \cup G_{i_n}.$$

(In the statement \mathbb{C} can be replaced by \mathbb{R}^k .)

We shall use this result in connection with a new concept of convergence for sequences of functions, particularly relevant for holomorphic functions.

Definition 4.14. Let $G \subseteq \mathbb{C}$ be an open set. A sequence of functions $f_n : G \rightarrow \mathbb{C}$ is said to converge *locally uniformly* to a function $f : G \rightarrow \mathbb{C}$ if

- (lu) To every $a \in G$ there exists $r > 0$ such that $\overline{K(a, r)} \subseteq G$ and $f_n(z) \rightarrow f(z)$ uniformly for $z \in \overline{K(a, r)}$.

If (lu) holds we have in particular $f_n(a) \rightarrow f(a)$ for every $a \in G$, i.e. $f_n \rightarrow f$ pointwise, and the convergence is assumed to be uniform in a suitable neighbourhood of every point in G . The question arises for which class of sets $K \subseteq G$ uniform convergence holds.

Theorem 4.15. *Let $G \subseteq \mathbb{C}$ be an open set. A sequence of functions $f_n : G \rightarrow \mathbb{C}$ converges locally uniformly to $f : G \rightarrow \mathbb{C}$ if and only if the following condition holds*

- (cu) *For every closed and bounded set $K \subseteq G$ we have $f_n(z) \rightarrow f(z)$ uniformly for $z \in K$.*

Proof. (lu) \Rightarrow (cu). Let $K \subseteq G$ be closed and bounded. For every $a \in K$ there exists $r = r_a > 0$ such that $\overline{K(a, r_a)} \subseteq G$ and $f_n \rightarrow f$ uniformly on $\overline{K(a, r_a)}$. The discs $(K(a, r_a))_{a \in K}$ are open and they cover K , because each $a \in K$ lies in the disc $K(a, r_a)$. By the covering theorem of Borel there exist finitely many points $a_1, \dots, a_n \in K$ such that

$$K \subseteq K(a_1, r_{a_1}) \cup \dots \cup K(a_n, r_{a_n}).$$

The sequence (f_n) being uniformly convergent on each of these discs, Remark 4.7 shows that $f_n \rightarrow f$ uniformly on K .

(cu) \Rightarrow (lu). Fix $a \in G$. We have to find a disc $\overline{K(a, r)} \subseteq G$, such that f_n converges uniformly to f on $\overline{K(a, r)}$. However, $\overline{K(a, r)}$ being closed and bounded, the uniform convergence on every such disc in G has been established. \square

Remark 4.16. The condition (cu) is an abbreviation for “compact-uniform” convergence, because closed and bounded subsets of \mathbb{C} (or \mathbb{R}^k) are often called *compact*. The condition thus reads that the convergence is uniform on every compact subset of G . We have seen that uniform convergence in a neighbourhood (no matter how small) of every point in the open set implies uniform convergence on arbitrary compact subsets of G .

We shall use Morera’s theorem to prove the following:

Theorem 4.17. *Let $G \subseteq \mathbb{C}$ be open. If a sequence f_1, f_2, \dots from $\mathcal{H}(G)$ converges locally uniformly in G to a function f , then $f \in \mathcal{H}(G)$, and the sequence f'_1, f'_2, \dots of derivatives converges locally uniformly in G to f' .*

Remark 4.18. By repeated application of the theorem we see that $f_n^{(p)} \rightarrow f^{(p)}$ locally uniformly in G for every $p \in \mathbb{N}$.

Proof. Let $a \in G$ and $\overline{K(a, r)} \subseteq G$ be such that $f_n \rightarrow f$ uniformly on $\overline{K(a, r)}$. By Theorem 4.2 f is continuous at every point of $K(a, r)$. For every triangle $\Delta \subseteq K(a, r)$ we have $\int_{\partial\Delta} f_n = 0$ by Cauchy’s integral theorem. Since $f_n \rightarrow f$ uniformly on $\partial\Delta$, we get

$$0 = \int_{\partial\Delta} f_n \rightarrow \int_{\partial\Delta} f$$

by Theorem 4.6 (i), hence $\int_{\partial\Delta} f = 0$. By Morera’s theorem f is holomorphic in $K(a, r)$, and a being arbitrary, we have proved that $f \in \mathcal{H}(G)$.

By Cauchy's integral formula for the derivative we get for $z_0 \in K(a, r)$

$$f'_n(z_0) - f'(z_0) = \frac{1}{2\pi i} \int_{\partial K(a, r)} \frac{f_n(z) - f(z)}{(z - z_0)^2} dz.$$

For $z_0 \in \overline{K(a, r/2)}$ and $z \in \partial K(a, r)$ we have $|(z - z_0)^2| \geq (r/2)^2$, hence

$$|f'_n(z_0) - f'(z_0)| \leq \frac{2\pi r}{2\pi} \left(\frac{2}{r}\right)^2 \sup_{z \in \partial K(a, r)} |f_n(z) - f(z)|,$$

which yields

$$\sup_{z_0 \in \overline{K(a, r/2)}} |f'_n(z_0) - f'(z_0)| \leq \frac{4}{r} \sup_{z \in \partial K(a, r)} |f_n(z) - f(z)|.$$

This shows that $f'_n \rightarrow f'$ uniformly on $\overline{K(a, r/2)}$, and since $a \in G$ is arbitrary we have proved that $f'_n \rightarrow f'$ locally uniformly in G . \square

Corollary 4.19. *Let $G \subseteq \mathbb{C}$ be open. Let f_0, f_1, \dots be a sequence of holomorphic functions on G and assume that the infinite series*

$$s(z) = \sum_{k=0}^{\infty} f_k(z), \quad z \in G \tag{1}$$

converges locally uniformly on G to a function $s : G \rightarrow \mathbb{C}$. Then $s \in \mathcal{H}(G)$ and the series can be differentiated term by term infinitely often

$$s^{(p)}(z) = \sum_{k=0}^{\infty} f_k^{(p)}(z), \quad z \in G, \quad p = 1, 2, \dots, \tag{2}$$

and each of these series converges locally uniformly on G .

Proof. By Definition 4.3 the sequence of partial sums

$$s_n(z) = \sum_{k=0}^n f_k(z)$$

converges locally uniformly on G to $s(z)$, and since $s_n \in \mathcal{H}(G)$ we conclude by Theorem 4.17 that $s \in \mathcal{H}(G)$. Furthermore, $s'_n(z)$ converges locally uniformly to $s'(z)$, i.e.

$$s'(z) = \sum_{k=0}^{\infty} f'_k(z),$$

which is (2) for $p = 1$. Formula (2) follows by repeated applications of the result. \square

Theorem 1.12 about differentiation term by term of a power series is of course a special case of Corollary 4.19.

Since an integral is a limit of finite sums, it is to be expected that an expression of the form

$$F(z) = \int_a^b f(x, z) dx$$

is holomorphic, if $f(x, z)$ is holomorphic in z for each x . We give a precise statement.

Theorem 4.20. *Let $G \subseteq \mathbb{C}$ be open and let $f : [a, b] \times G \rightarrow \mathbb{C}$ be a continuous function such that $f(x, \cdot) \in \mathcal{H}(G)$ for each $x \in [a, b]$. Then*

- (i) $\frac{\partial^n f}{\partial z^n} : [a, b] \times G \rightarrow \mathbb{C}$ is continuous for $n = 1, 2, \dots$,
- (ii) $F(z) = \int_a^b f(x, z) dx$ is holomorphic in G ,

and for $n = 1, 2, \dots$

$$F^{(n)}(z) = \int_a^b \frac{\partial^n f}{\partial z^n}(x, z) dx, \quad z \in G \quad (3)$$

Proof. (a) We prove first that $\frac{\partial f}{\partial z}$ is continuous at $(x_0, z_0) \in [a, b] \times G$. Choose $r > 0$ such that $\overline{K}(z_0, r) \subseteq G$. For $x \in [a, b]$, $z \in K(z_0, r)$ we have by Cauchy's integral formula for the derivative

$$\frac{\partial f}{\partial z}(x, z) = \frac{1}{2\pi i} \int_{\partial K(z_0, r)} \frac{f(x, w)}{(w - z)^2} dw. \quad (4)$$

The function $G(x, z, w) = f(x, w)/(w - z)^2$ is continuous on $[a, b] \times K(z_0, r) \times \partial K(z_0, r)$. Applying Theorem A.7 with $A = [a, b] \times K(z_0, r)$ and $B = \partial K(z_0, r)$, we see that for given $\varepsilon > 0$

$$\left| \frac{f(x, w)}{(w - z)^2} - \frac{f(x_0, w)}{(w - z_0)^2} \right| < \varepsilon \quad \text{for all } w \in \partial K(z_0, r) \quad (5)$$

provided (x, z) is sufficiently close to (x_0, z_0) . For (x, z) such that (5) holds, it follows by (4) and by the estimation lemma 2.8 that

$$\left| \frac{\partial f}{\partial z}(x, z) - \frac{\partial f}{\partial z}(x_0, z_0) \right| \leq r\varepsilon,$$

hence that $\frac{\partial f}{\partial z}$ is continuous at (x_0, z_0) .

(b) We next prove (ii) and (3) for $n = 1$. For $g \in \mathcal{H}(G)$ and $K(z_0, r) \subseteq G$ we have for $|h| < r$

$$g(z_0 + h) - g(z_0) = \int_0^1 \frac{d}{dt} g(z_0 + th) dt = h \int_0^1 g'(z_0 + th) dt.$$

Applying this to $g(z) = f(x, z)$ for each $x \in [a, b]$ we get

$$f(x, z_0 + h) - f(x, z_0) = h \int_0^1 \frac{\partial f}{\partial z}(x, z_0 + th) dt,$$

hence by integrating over $[a, b]$

$$\frac{1}{h} (F(z_0 + h) - F(z_0)) = \int_a^b \left(\int_0^1 \frac{\partial f}{\partial z}(x, z_0 + th) dt \right) dx, \quad 0 < |h| < r.$$

By (i) for $n = 1$ the function $(h, x, t) \rightarrow \frac{\partial f}{\partial z}(x, z_0 + th)$ is continuous on $K(0, r) \times [a, b] \times [0, 1]$. Given $\varepsilon > 0$ we see by Theorem A.7 that

$$\left| \frac{\partial f}{\partial z}(x, z_0) - \frac{\partial f}{\partial z}(x, z_0 + th) \right| < \varepsilon,$$

for all $x \in [a, b], t \in [0, 1]$, provided $|h| < \delta$ for a sufficiently small $\delta > 0$. This gives for $0 < |h| < \delta$

$$\begin{aligned} & \left| \int_a^b \frac{\partial f}{\partial z}(x, z_0) dx - \frac{1}{h} (F(z_0 + h) - F(z_0)) \right| \\ &= \left| \int_a^b \left(\int_0^1 \left(\frac{\partial f}{\partial z}(x, z_0) - \frac{\partial f}{\partial z}(x, z_0 + th) \right) dt \right) dx \right| \leq \varepsilon(b - a), \end{aligned}$$

which shows that F is complex differentiable at z_0 with

$$F'(z_0) = \int_a^b \frac{\partial f}{\partial z}(x, z_0) dx.$$

Since $\frac{\partial f}{\partial z}(x, \cdot) \in \mathcal{H}(G)$ for each $x \in [a, b]$, we can apply to $\frac{\partial f}{\partial z}$ what we have already proved. This gives (i) and (3) for $n = 2$. It is clear the the process can be repeated to give (i) and (3) for all n . \square

4.5. Entire functions. Liouville's theorem.

A holomorphic function $f: \mathbb{C} \rightarrow \mathbb{C}$ is called an *entire function*. Polynomials, \exp , \sin , \cos , \sinh , \cosh are entire functions, but $\frac{1}{z}$ is not entire. For an entire function the formula (1) of Theorem 4.8 holds for all $z, a \in \mathbb{C}$ and in particular for $a = 0$. The study of entire functions is therefore equivalent with the study of power series with infinite radius of convergence. We can think informally of entire functions as “polynomials of infinite degree”.

There is a long list of deep and interesting theorems about entire functions. We mention the following without proof:

Theorem 4.21. Picard's theorem. *Let $f : \mathbb{C} \rightarrow \mathbb{C}$ be a non-constant entire function. Then either $f(\mathbb{C}) = \mathbb{C}$ or $f(\mathbb{C}) = \mathbb{C} \setminus \{a\}$ for a suitable point $a \in \mathbb{C}$. If f is different from a polynomial, then for all $w \in \mathbb{C}$ with at most one exception, the equation $f(z) = w$ has infinitely many solutions z .*

As illustration of the theorem take $f(z) = \exp z$. The equation $\exp z = w$ has no solutions when $w = 0$, but for $w \neq 0$ there are infinitely many solutions. More about this will be discussed in Section 5.4.

Picard's theorem shows that a bounded entire function is constant. We give a complete proof of this result which is known as Liouville's theorem.

Theorem 4.22. Liouville's theorem. *A bounded entire function is constant.*

Proof. Assume that f is an entire function such that $|f(z)| \leq M$ for all $z \in \mathbb{C}$. By Cauchy's integral formula for the derivatives we get for any $r > 0$

$$|f^{(n)}(0)| = \left| \frac{n!}{2\pi i} \int_{\partial K(0,r)} \frac{f(z)}{z^{n+1}} dz \right| \leq \frac{n!}{2\pi} \frac{M}{r^{n+1}} 2\pi r = \frac{M \cdot n!}{r^n}.$$

Letting $r \rightarrow \infty$ (which is possible because f is entire), we see that $f^{(n)}(0) = 0$ for all $n \geq 1$, and the assertion follows from the Taylor expansion of f . \square

4.6. Polynomials.

Liouville's theorem is quite deep, although it is simple to prove. The depth is illustrated by the following application:

Theorem 4.23. The fundamental theorem of algebra. *Every polynomial $p(z) = \sum_{k=0}^n a_k z^k$ of degree $n \geq 1$ has at least one zero (=root) in \mathbb{C} .*

Proof. Assuming $p(z) \neq 0$ for all $z \in \mathbb{C}$, we see that $f(z) = 1/p(z)$ must be an entire function.

By the assumption of p being of degree n we have $a_n \neq 0$, which allows us to write

$$p(z) = a_n z^n \left(1 + \sum_{k=0}^{n-1} \frac{a_k}{a_n} z^{k-n} \right),$$

hence

$$\frac{p(z)}{a_n z^n} \rightarrow 1 \quad \text{for } |z| \rightarrow \infty.$$

By this result there exists $r > 0$ such that

$$\left| \frac{p(z)}{a_n z^n} \right| \geq \frac{1}{2} \quad \text{for } |z| \geq r$$

or

$$\frac{1}{|p(z)|} \leq \frac{2}{|a_n| r^n} \quad \text{for } |z| \geq r.$$

The continuous function $1/|p(z)|$ is also bounded on the closed and bounded set $\overline{K(0, r)}$, hence $1/p$ is a bounded entire function and finally constant by Liouville's theorem. This contradiction shows that p has at least one zero. \square

For the set of polynomials

$$p(z) = a_0 + a_1 z + \cdots + a_n z^n$$

with complex coefficients we use the standard notation $\mathbb{C}[z]$ from algebra.

We recall the following fundamental result about *division of polynomials*:

Theorem 4.24. *Let $d \in \mathbb{C}[z]$ be different from the zero polynomial. To $p \in \mathbb{C}[z]$ there exist uniquely determined polynomials $q, r \in \mathbb{C}[z]$ such that*

$$p = qd + r, \quad \deg(r) < \deg(d).^{1)}$$

If d, p have real coefficients, then so have q, r .

The polynomials d, q, r are called *divisor, quotient and remainder* respectively.

Proof. To see the uniqueness statement let $p = q_1 d + r_1 = q_2 d + r_2$ where $\deg(r_j) < \deg(d)$, $j = 1, 2$. By subtraction we get $(q_1 - q_2)d = r_2 - r_1$, which is a polynomial of degree $< \deg(d)$, but this is only possible if $q_1 - q_2 = 0$, and then we also have $r_1 = r_2$.

The existence can be seen by induction in $\deg(p)$. If $\deg(p) < \deg(d)$ the existence is clear by defining $q = 0$, $r = p$. Assume next that we have proved the existence for $\deg(p) \leq n - 1$, and let us prove it for $\deg(p) = n$. Calling $\deg(d) = k$, we can write

$$p(z) = a_n z^n + \cdots + a_0, \quad d(z) = b_k z^k + \cdots + b_0,$$

where $a_n \neq 0$, $b_k \neq 0$. As already seen, we can assume $n \geq k$.

¹⁾ The zero polynomial is assigned the degree $-\infty$

The polynomial

$$p_1(z) = p(z) - \frac{a_n}{b_k} z^{n-k} d(z) = \\ a_{n-1} z^{n-1} + \cdots + a_0 - \frac{a_n}{b_k} (b_{k-1} z^{n-1} + \cdots + b_0 z^{n-k})$$

has degree $\leq n-1$, so by the induction hypothesis we can find polynomials q_1, r_1 such that

$$p_1 = q_1 d + r_1, \quad \deg(r_1) < \deg(d),$$

hence

$$p(z) = p_1(z) + \frac{a_n}{b_k} z^{n-k} d(z) = \left(q_1(z) + \frac{a_n}{b_k} z^{n-k} \right) d(z) + r_1(z).$$

□

Example 4.25. $p(z) = 2z^3 + 3z^2 + z + 3$, $d(z) = z^2 - z + 1$

$$\begin{array}{r} z^2 - z + 1 \overline{) 2z^3 + 3z^2 + z + 3} \\ \underline{2z^3 - 2z^2 + 2z} \\ 5z^2 - z + 3 \\ \underline{5z^2 - 5z + 5} \\ 4z - 2 \end{array}$$

This gives $q(z) = 2z + 5$, $r(z) = 4z - 2$.

Example 4.26. Let $d(z) = z - a$ be of degree one. The theorem yields $p(z) = q(z)(z - a) + r$, where $r \in \mathbb{C}$. Inserting $z = a$ gives $r = p(a)$. A zero $z = a$ of p therefore leads to the factorization $p(z) = q(z)(z - a)$.

A repeated use of this gives

Corollary 4.27. *A polynomial $p(z)$ of degree $n \geq 1$ has precisely n zeros in \mathbb{C} counted with multiplicity. Denoting z_1, \dots, z_k the different zeros of p having the multiplicities n_1, \dots, n_k respectively, we have*

$$p(z) = a_n (z - z_1)^{n_1} \cdots (z - z_k)^{n_k},$$

where a_n is the leading coefficient.

Proof. For $n = 1$ the theorem is trivial. Assume that we have proved the Corollary for polynomials of degree $n-1$ and let us prove it for a polynomial p of degree $n > 1$. By Theorem 4.23 we can factorize $p(z) = (z - z_1)q(z)$ for some zero z_1 of p . Since q has degree $n-1$ we know by the induction hypothesis that it has $n-1$ zeros counted with multiplicity. Therefore p has n zeros. The given factorization also follows by induction. □

Exercises for §4.

4.1. Let G be an open subset of \mathbb{C} and let $a \in G$. Assume that $f \in \mathcal{H}(G)$ satisfies $f'(a) \neq 0$.

Prove that there exists $r > 0$, such that $|f'(z) - f'(a)| < |f'(a)|$ for $z \in K(a, r) \subseteq G$. Show next that

$$\left| \int_0^1 f'(tz_2 + (1-t)z_1) dt - f'(a) \right| < |f'(a)|,$$

$$f(z_2) - f(z_1) = (z_2 - z_1) \int_0^1 f'(tz_2 + (1-t)z_1) dt,$$

for arbitrary $z_1, z_2 \in K(a, r)$, and deduce that $f|_{K(a, r)}$ is one-to-one.

In summary we have proved: *f is one-to-one in a sufficiently small neighbourhood of a point a for which f'(a) ≠ 0.*

Give an example of an entire function f which is not one-to-one but such that $f'(z) \neq 0$ for all $z \in \mathbb{C}$.

4.2. Find the Taylor series with centre $\pi/4$ for the sine function in the following two ways: (i) Use the addition formula. (ii) Determine the coefficients by differentiation.

4.3. What is the largest domain $G \subseteq \mathbb{C}$ for which $f(z) = 1/(1 - z + z^2)$ is holomorphic? Show that $f(z) = \sum_0^\infty a_n z^n$ for $|z| < 1$, and that $a_0 = a_1 = 1$, $a_2 = 0$, and $a_{n+3} = -a_n$ for $n \geq 0$.

Hint. Use that $1 = (1 - z + z^2) \sum_0^\infty a_n z^n$ and apply Theorem 1.14.

4.4. Determine the value of

$$\int_{\partial K(i, 2)} \frac{e^z}{(z-1)^n} dz \quad \text{for } n \geq 1.$$

4.5. Let $u : G \rightarrow \mathbb{R}$ be a harmonic function in an open set $G \subseteq \mathbb{C}$. Assuming $\overline{K(a, r)} \subseteq G$, show that

$$u(a) = \frac{1}{2\pi} \int_0^{2\pi} u(a + re^{i\theta}) d\theta.$$

4.6. Show that

$$u(x, y) = \frac{x}{x^2 + y^2} \quad \text{and} \quad u(x, y) = x^2 - y^2$$

are harmonic functions in $\mathbb{R}^2 \setminus \{(0, 0)\}$ respectively \mathbb{R}^2 , and find conjugate harmonic functions.

4.7. Let (f_n) be a sequence of holomorphic functions in an open set G and assume that

$$\sum_{n=1}^{\infty} \sup_K |f_n(z)| < \infty,$$

for every closed and bounded set K in \mathbb{C} such that $K \subseteq G$. Show that

$$f(z) = \sum_{n=1}^{\infty} f_n(z)$$

is holomorphic in G , and that $f'(z) = \sum_{n=1}^{\infty} f'_n(z)$, where the series converges locally uniformly on G .

4.8. Let K and L be closed and bounded sets in \mathbb{C} such that $K \neq \emptyset$ and $K \subseteq \overset{\circ}{L}$, and let d denote the distance between K and $\mathbb{C} \setminus \overset{\circ}{L}$, i.e.

$$d = \inf\{|z - w| \mid z \in K, w \in \mathbb{C} \setminus \overset{\circ}{L}\}.$$

Explain why $d > 0$ and prove that for every open set $G \supseteq L$ and for every $f \in \mathcal{H}(G)$

$$\sup_K |f'(z)| \leq \frac{1}{d} \sup_L |f(z)|.$$

Hint. Explain why it is possible to apply Cauchy's integral formula

$$f'(a) = \frac{1}{2\pi i} \int_{\partial K(a,d)} \frac{f(\xi)}{(\xi - a)^2} d\xi \quad \text{for } a \in K.$$

4.9. Let f be an entire function and assume that

$$|f(z)| \leq A + B|z|^n \quad \text{for } z \in \mathbb{C},$$

where $A, B \geq 0$ and $n \in \mathbb{N}$. Prove that f is a polynomial of degree $\leq n$.

4.10. Let f be a non-constant entire function. Prove (without referring to Picard's Theorem) that $\overline{f(\mathbb{C})} = \mathbb{C}$.

Hint. Assume that $\overline{f(\mathbb{C})} \neq \mathbb{C}$, and try to apply Liouville's theorem.

4.11. Let f be an entire function satisfying $f' = af$ for some $a \in \mathbb{C}$. Show that there exists $c \in \mathbb{C}$ such that

$$f(z) = c \exp(az), \quad z \in \mathbb{C}.$$

4.12. Let $\varphi \in \mathcal{H}(G)$. Show that the infinite series

$$f(z) = \sum_{n=1}^{\infty} \sin\left(\frac{\varphi(z)}{n^2}\right)$$

defines a holomorphic function in G .

4.13. (Requires basic measure theory). Let (X, \mathbb{E}, μ) be a measurable space and let $G \subseteq \mathbb{C}$ be open. Assume that $f : X \times G \rightarrow \mathbb{C}$ satisfies

- (i) $\forall x \in X : f(x, \cdot) \in \mathcal{H}(G)$.
- (ii) $\forall z \in G : f(\cdot, z)$ is measurable on X .
- (iii) There exists a measurable function $g : X \rightarrow [0, \infty]$ satisfying $\int g d\mu < \infty$, such that

$$|f(x, z)| \leq g(x) \quad \text{for } x \in X, z \in G.$$

1°. Prove that $\frac{\partial f}{\partial z}(\cdot, z)$ is measurable for each $z \in G$.

2°. Assume that $\overline{K(z_0, r)} \subseteq G$. Prove that

$$\left| \frac{\partial f}{\partial z}(x, z) \right| \leq \frac{4}{r} g(x), \quad z \in K(z_0, r/2), x \in X.$$

and that

$$\frac{1}{h} (f(x, z_0 + h) - f(x, z_0)) = \int_0^1 \frac{\partial f}{\partial z}(x, z_0 + th) dt, \quad 0 < |h| < r, x \in X.$$

3°. Prove that

$$F(z) = \int_X f(x, z) d\mu(x), \quad z \in G,$$

is holomorphic in G and

$$F'(z) = \int_X \frac{\partial f}{\partial z}(x, z) d\mu(x), \quad z \in G.$$

Remark. Notice that (iii) can be replaced by local conditions: For each $a \in G$ there exist a disc $K(a, r) \subseteq G$ and a “majorant” g , both depending on a such that

$$|f(x, z)| \leq g(x) \quad \text{for } x \in X, z \in K(a, r).$$

Notice also that in this version the results can be applied to $\frac{\partial f}{\partial z}$, so the final conclusion is that we can differentiate the integral infinitely often by differentiating under the integral sign:

$$F^{(n)}(z) = \int \frac{\partial^n f}{\partial z^n}(x, z) d\mu(x), \quad z \in G, n \in \mathbb{N}.$$

4.14. Explain why the power series $\sum_{n=0}^{\infty} z^n$ converges uniformly to $\frac{1}{1-z}$ for $z \in \overline{K(0, r)}$ for every $r < 1$. Prove that the series does *not* converge uniformly on $K(0, 1)$.

4.15. Let $p(z) = a_0 + a_1z + \cdots + a_nz^n$ be a polynomial of degree $n \geq 1$ with *real* coefficients. Prove that if $z = a$ is a zero of p , then so is $z = \bar{a}$ and of the same multiplicity as a . Prove that if n is *odd*, then p has at least one real zero.

4.16. Assume that $f \in \mathcal{H}(K(0, r))$ has the power series

$$f(z) = 1 + a_1z + a_2z^2 + \cdots \quad \text{for } |z| < r.$$

Prove that there exists $\rho > 0$ such that $1/f \in \mathcal{H}(K(0, \rho))$ and that the coefficients (b_n) in the power series

$$\frac{1}{f(z)} = \sum_{n=0}^{\infty} b_n z^n, \quad |z| < \rho$$

satisfy

$$b_0 = 1, \quad b_1 = -a_1, \quad b_2 = a_1^2 - a_2.$$

4.17. Let $p(z) = \sum_{k=0}^n a_{n-k}z^k$ be a polynomial of degree $n \geq 1$, i.e. $a_0 \neq 0$, and assume that $a_{n-k} = a_k, k = 0, 1, \dots, n$.

Prove that if z is a zero of p , then $z \neq 0$ and $1/z$ is also a zero of p .

Find the zeros of the polynomial $2z^4 - 3z^3 - z^2 - 3z + 2$.

Hint. $z = 2$ is a zero of p .

4.18. Show that the functions

$$u(x, y) = e^x \cos y, \quad u(x, y) = \sin x \cosh y, \quad u(x, y) = \cos x \cosh y$$

are harmonic in \mathbb{R}^2 and find entire functions having u as real part.

4.19. Prove that the series

$$\sum_{n=1}^{\infty} \frac{1}{n^z} \quad (n^z := \exp(z \ln n), z \in \mathbb{C})$$

is absolutely convergent for all $z \in \mathbb{C}$ with $\operatorname{Re} z > 1$, and that the sum

$$\zeta(z) = \sum_{n=1}^{\infty} \frac{1}{n^z}, \quad \operatorname{Re} z > 1$$

defines a holomorphic function in the open half-plane $\operatorname{Re} z > 1$. This is the famous *Riemann zeta function*.

Let $p_1 = 2, p_2 = 3, p_3 = 5, \dots$ denote the sequence of prime numbers. Prove that

$$\left| \zeta(z) \prod_{k=1}^N \left(1 - \frac{1}{p_k^z}\right) - 1 \right| \leq \sum_{n=p_{N+1}}^{\infty} \frac{1}{n^{\operatorname{Re} z}}, \quad \operatorname{Re} z > 1,$$

and conclude that $\zeta(z) \neq 0$ and

$$\lim_{N \rightarrow \infty} \prod_{k=1}^N \left(1 - \frac{1}{p_k^z}\right) = \frac{1}{\zeta(z)}, \quad \operatorname{Re} z > 1.$$

4.20. (i) Prove that

$$f(t) = \begin{cases} -t \ln t, & 0 < t \leq 1 \\ 0, & t = 0 \end{cases}$$

is a continuous function on $[0, 1]$ and

$$\int_0^1 (f(t))^n dt = \frac{n!}{(n+1)^{n+1}}, \quad n = 0, 1, \dots$$

Hint. Use or prove by induction that $\int_0^{\infty} x^n \exp(-x) dx = n!$.

(ii) Prove that

$$F(z) = \int_0^1 \exp(zf(t)) dt, \quad z \in \mathbb{C}$$

is an entire function with the power series

$$F(z) = \sum_{n=0}^{\infty} \frac{z^n}{(n+1)^{n+1}}, \quad z \in \mathbb{C}.$$

(iii) Prove that

$$F(1) = \int_0^1 \frac{dt}{t} = \sum_{n=1}^{\infty} \frac{1}{n^n}.$$



Karl Weierstrass (1815–1897), German

§5. Argument. Logarithm. Powers

This section is focusing on the concept of argument of a complex number. The argument being only determined modulo 2π , it is important to be able to choose the argument in such a way that it depends continuously on the points in question. It turns out that we can choose the argument in a continuous way in two situations: For the points along a continuous curve in $\mathbb{C} \setminus \{0\}$ (Theorem 5.10), and for the points in a simply connected domain $G \subseteq \mathbb{C} \setminus \{0\}$ (Theorem 5.15). Notice that in both cases we have to avoid the point zero, where the argument is not defined.

To prove these results we have to discuss the concept of path connectedness from general topology, thereby bringing our preliminary definition of a domain in accordance with the definitions of general topology.

Using a continuously varying argument along a continuous curve, we can define precisely how many times it winds around zero. This is the winding number.

Logarithms, n 'th roots and powers of arbitrary exponent are multi-valued functions. We examine how we can choose branches of these functions such that they become ordinary holomorphic functions.

There is another way of treating multi-valued functions, going back to Riemann. We stack copies (layers) of the complex plane and glue them together along certain curves such that it becomes possible to move from one layer to the next. All the layers are then viewed as one entity called a Riemann surface. This is only an inaccurate picture. If the multi-valued function has n values ($n = 2, 3, \dots, \infty$) at a point $z_0 \in \mathbb{C}$ we shall stack n layers over that point. We will only discuss the most simple example \sqrt{z} , which needs a Riemann surface with two layers. The theory of Riemann surfaces is comprehensive and complicated and has been a source of inspiration for the general theory of differentiable manifolds.

5.1. Some topological concepts.

All definitions and results in this subsection 5.1 are formulated for the complex plane, but could just as well have been formulated for \mathbb{R}^k .

Definition 5.1. A subset $A \subseteq \mathbb{C}$ is called *path connected*, if two arbitrary points from A can be connected by a continuous curve contained in A .

In other words, given $P, Q \in A$ there exists a continuous function $\gamma : [0, 1] \rightarrow \mathbb{C}$ such that $\gamma(0) = P$, $\gamma(1) = Q$ and $\gamma(t) \in A$ for all $t \in [0, 1]$.

If a set $A \subseteq \mathbb{C}$ is star-shaped with respect to $P_0 \in A$, then A is path connected.

We first notice that an arbitrary point $P \in A$ is connected to P_0 by the line segment $\gamma(t) = (1-t)P_0 + tP$. If δ is a similar line segment from P_0 to $Q \in A$, then $\{-\gamma\} \cup \delta$ defines a continuous curve from P to Q .

In particular every convex set is path connected.

Every domain is path connected, since two arbitrary points can be connected by a staircase line, cf. Definition 1.8.

A circle is path connected but it is of course not possible to connect two different points on the circle by a staircase line.

We will prove that in a path connected open subset of \mathbb{C} there is enough space to make it possible to connect any two points by a staircase line.

As a preparation we prove a useful result called the “paving lemma”, because it “shows” that a garden path can be covered by a finite number of circular flagstones of the same size (although we allow them to be overlapping contrary to reality).

5.2. The paving lemma. *Let G be an open subset of \mathbb{C} and let $\gamma : [a, b] \rightarrow G$ be a continuous curve in G .*

There exist finitely many points $a = t_0 < t_1 < \dots < t_n = b$ in the interval $[a, b]$ and a radius $r > 0$ such that

$$\bigcup_{i=0}^n K(\gamma(t_i), r) \subseteq G \quad (1)$$

and

$$\gamma([t_i, t_{i+1}]) \subseteq K(\gamma(t_i), r), \quad i = 0, 1, \dots, n-1. \quad (2)$$

Proof. By a main theorem of analysis γ is uniformly continuous. Given $\varepsilon = r > 0$, there exists $\delta > 0$ such that $|\gamma(t) - \gamma(s)| < r$ provided $t, s \in [a, b]$ satisfy $|t - s| \leq \delta$. We now divide the interval $[a, b]$ by finitely many points t_i as above such that $t_{i+1} - t_i \leq \delta$ for each i . Then (2) clearly holds. If $G = \mathbb{C}$, then (1) holds for any $r > 0$. The set $\gamma([a, b])$ is closed and bounded, cf. Theorem A.3. If $G \neq \mathbb{C}$, there is a positive distance d between $\gamma([a, b])$ and the closed set $\mathbb{C} \setminus G$, cf. Lemma A.1. By choosing $r < d$ both (1) and (2) hold provided $\delta > 0$ is chosen in accordance with the uniform continuity corresponding to $\varepsilon = r$. \square

Theorem 5.3. *An open path connected set $G \subseteq \mathbb{C}$ is a domain⁵ in the sense that any two points in G can be connected by a staircase line belonging to G .*

Proof. Let $P, Q \in G$ and let $\gamma : [0, 1] \rightarrow \mathbb{C}$ be a continuous curve in G from P to Q . By the paving lemma there exist points $0 = t_0 < \dots < t_n = 1$ and $r > 0$ such that (1) and (2) hold.

⁵Recall Definition 1.8

In a disc $K(a, r)$ an arbitrary point $P \in K(a, r)$ can be connected to the centre a by a staircase line consisting of at most two line segments. We are now able to construct a staircase line from $\gamma(0) = P$ to $\gamma(1) = Q$ by first moving to $\gamma(t_1)$ in the disc $K(\gamma(0), r)$, next moving from $\gamma(t_1)$ to $\gamma(t_2)$ in the disc $K(\gamma(t_1), r)$, next moving from $\gamma(t_2)$ to $\gamma(t_3)$ in the disc $K(\gamma(t_2), r)$ and so on. Because of (1), the total staircase line is contained in G . \square

Definition 5.4. Let $A \subseteq \mathbb{C}$ be given. A point $a \in \mathbb{C}$ is called an *accumulation point* or a *cluster point* of A if

$$\forall r > 0 : K'(a, r) \cap A \neq \emptyset.$$

In other words, it shall be possible to find points $x \in A$ which are arbitrarily close to a but different from a . This is equivalent to the existence of a sequence $x_n \in A \setminus \{a\}$ such that $x_n \rightarrow a$ for $n \rightarrow \infty$. A point $a \in A$, which is not an accumulation point of A , is called *isolated* in A . It is characterized by the requirement

$$\exists r > 0 : K(a, r) \cap A = \{a\}.$$

Definition 5.5. Let $G \subseteq \mathbb{C}$ be open. A set $A \subseteq G$ is called *discrete* in G , if A has no accumulation points in G .

Examples. For $A = \mathbb{R}$ and for $A = \mathbb{Q}$ the accumulation points are precisely the points of \mathbb{R} . The set $A = \mathbb{Z}$ or an arbitrary set $A \subseteq \mathbb{Z}$ is discrete in \mathbb{C} . The set $A = \{\frac{1}{n} \mid n \in \mathbb{N}\}$ is discrete in $\mathbb{C} \setminus \{0\}$, but 0 is an accumulation point of A .

Theorem 5.6. Let $G \subseteq \mathbb{C}$ be open. A discrete set $A \subseteq G$ is countable (see A.9) and $G \setminus A$ is open.⁶

Proof. An arbitrary point $a \in G$ is not an accumulation point of A , hence there exists $r = r_a > 0$ such that

$$K'(a, r_a) \cap A = \emptyset. \quad (3)$$

We can also assume that $K(a, r_a) \subseteq G$, for otherwise we just replace r_a by a smaller radius.

If $a \in G \setminus A$ we even have $K(a, r_a) \cap A = \emptyset$, hence $K(a, r_a) \subseteq G \setminus A$. This shows that $G \setminus A$ is open.

If $a \in A$ we have

$$K(a, r_a) \cap A = \{a\}. \quad (4)$$

Let now $K \subseteq G$ be a closed and bounded set. The discs $\{K(a, r_a) \mid a \in K\}$ form an open covering of K . By Borel's covering theorem 4.13, we can find $a_1, \dots, a_n \in K$ such that

$$K \subseteq K(a_1, r_{a_1}) \cup \dots \cup K(a_n, r_{a_n}),$$

⁶We can also say that A is closed relative to G .

hence

$$A \cap K \subseteq \bigcup_{i=1}^n A \cap K(a_i, r_{a_i}) \subseteq \{a_1, \dots, a_n\}.$$

This shows that $A \cap K$ is a finite set.

We finish the proof by making use of the following important fact: There exists a sequence $K_1 \subseteq K_2 \subseteq \dots$ of closed and bounded subsets of G exhausting G , i.e. having G as their union, cf. Theorem A.5.

Therefore A is the union of the finite sets $A \cap K_n$, $n = 1, 2, \dots$ and hence countable by Theorem A.11. \square

Theorem 5.7. *Let $f : A \rightarrow \mathbb{C}$ be a continuous function defined on a path connected set $A \subseteq \mathbb{C}$, and assume that $f(A)$ is discrete in \mathbb{C} .*

Then f is constant.

Proof. Fix $P_0 \in A$. We shall prove that $f(P) = f(P_0)$ for arbitrary $P \in A$. To $P \in A$ we choose a continuous curve $\gamma : [0, 1] \rightarrow \mathbb{C}$ such that $\gamma(0) = P_0$, $\gamma(1) = P$ and $\gamma(t) \in A$ for $t \in [0, 1]$.

Since $f(A)$ is discrete in \mathbb{C} , there exists $r > 0$ such that

$$K(f(P_0), r) \cap f(A) = \{f(P_0)\},$$

cf. (4), but $f \circ \gamma : [0, 1] \rightarrow \mathbb{C}$ being continuous at 0, there exists $\delta_0 > 0$ such that

$$\forall t \in [0, 1] : 0 \leq t \leq \delta_0 \Rightarrow |f(\gamma(t)) - f(\gamma(0))| < r,$$

hence

$$0 \leq t \leq \delta_0 \Rightarrow f(\gamma(t)) \in K(f(P_0), r) \cap f(A) = \{f(P_0)\}.$$

This shows that $f(\gamma(t))$ is equal to $f(P_0)$ for $t \in [0, \delta_0]$. The idea is now roughly speaking that since $f(\gamma(\delta_0)) = f(P_0)$, an argument as before proves that $f(\gamma(t)) = f(P_0)$ for $t \in [\delta_0, \delta_0 + \delta]$ for a sufficiently small δ , and after a finite number of steps we reach $t = 1$. However, one can fear that each new step δ can be smaller and smaller in such a way that we never reach $t = 1$. We therefore have to be more precise.

Define

$$E = \{t \in [0, 1] \mid \forall s \in [0, t] : f(\gamma(s)) = f(P_0)\}.$$

We have seen that $[0, \delta_0] \subseteq E$, and defining $t_0 := \sup E$ we get $\delta_0 \leq t_0 \leq 1$.

Since $f(A)$ is assumed to be discrete in \mathbb{C} we know that $f(\gamma(t_0))$ is not an accumulation point of $f(A)$. Therefore, there exists $r > 0$ such that

$$K(f(\gamma(t_0)), r) \cap f(A) = \{f(\gamma(t_0))\},$$

cf. (4), and $f \circ \gamma$ being continuous at t_0 , there exists $\delta > 0$ such that

$$\forall t \in [0, 1] : t_0 - \delta \leq t \leq t_0 + \delta \Rightarrow |f(\gamma(t)) - f(\gamma(t_0))| < r,$$

hence

$$t \in [0, 1] \cap [t_0 - \delta, t_0 + \delta] \Rightarrow f(\gamma(t)) = f(\gamma(t_0)). \quad (5)$$

Using $t_0 = \sup E$, there exists $t_1 \in E \cap [t_0 - \delta, t_0]$, but then

$$f(P_0) = f(\gamma(t_1)) = f(\gamma(t_0)). \quad (6)$$

The claim is now that $t_0 = 1$. In fact, if $t_0 < 1$ we get by (5) and (6) that

$$f(\gamma(t)) = f(P_0) \quad \text{for } t \in [0, t_0 + \delta] \cap [0, 1],$$

showing that $\min(t_0 + \delta, 1) \in E$, but this contradicts the definition of t_0 .

From $t_0 = \sup E = 1$ we get $f(\gamma(s)) = f(P_0)$ for all $s \in [0, 1[$, and by continuity this also holds for $s = 1$, hence $f(P) = f(P_0)$. \square

5.2. Argument function, winding number.

For $z \in \mathbb{C} \setminus \{0\}$ we denote by $\arg z$ the set of arguments of z , i.e. the set of numbers $\theta \in \mathbb{R}$ such that $z = |z|e^{i\theta}$. The *principal argument* $\text{Arg } z$ is the uniquely determined argument belonging to $] -\pi, \pi]$, i.e.

$$\text{Arg } z \in \arg z \cap] -\pi, \pi], \quad \arg z = \text{Arg } z + 2\pi\mathbb{Z}. \quad (1)$$

Given a set $A \subseteq \mathbb{C} \setminus \{0\}$, a function $\theta : A \rightarrow \mathbb{R}$ is called an *argument function* of A if $\theta(z) \in \arg z$ for $z \in A$ or equivalently if $z = |z|e^{i\theta(z)}$ for $z \in A$.

The principal argument Arg is a continuous argument function of the *cut plane*

$$\mathbb{C}_\pi := \mathbb{C} \setminus \{z \in \mathbb{R} \mid z \leq 0\}. \quad (2)$$

This is geometrically intuitive, but follows rigorously from⁷

$$\begin{aligned} \text{Arg } z &= \text{Arccos } \frac{x}{r}, & \text{when } z &= x + iy, y > 0, \\ \text{Arg } z &= \text{Arctan } \frac{y}{x}, & \text{when } z &= x + iy, x > 0, \\ \text{Arg } z &= -\text{Arccos } \frac{x}{r}, & \text{when } z &= x + iy, y < 0, \end{aligned}$$

($r = |z|$); these expressions even show that Arg is a real-valued C^∞ -function in the cut plane.

Fix $\alpha \in \mathbb{R}$. Similarly we can define an argument function Arg_α of the cut plane

$$\mathbb{C}_\alpha := \mathbb{C} \setminus \{re^{i\alpha} \mid r \geq 0\} \quad (3)$$

⁷ $\text{Arccos} : [-1, 1] \rightarrow [0, \pi]$ is the inverse function of $\cos : [0, \pi] \rightarrow [-1, 1]$; $\text{Arctan} : \mathbb{R} \rightarrow]-\frac{\pi}{2}, \frac{\pi}{2}[$ is the inverse function of $\tan :]-\frac{\pi}{2}, \frac{\pi}{2}[\rightarrow \mathbb{R}$.

by

$$\operatorname{Arg}_\alpha z \in \arg z \cap]\alpha - 2\pi, \alpha[, \quad (4)$$

i.e. $\operatorname{Arg} = \operatorname{Arg}_\pi$ on \mathbb{C}_π . Using

$$\operatorname{Arg}_\alpha z = \operatorname{Arg} \left(e^{i(\pi-\alpha)} z \right) + \alpha - \pi \quad \text{for } z \in \mathbb{C}_\alpha,$$

we see that $\operatorname{Arg}_\alpha$ is a real-valued C^∞ -function on \mathbb{C}_α .

Arg and $\operatorname{Arg}_\alpha$ are examples of continuous argument functions attached to specific sub-domains of $\mathbb{C} \setminus \{0\}$. In general we have:

Lemma 5.8. *Let $\theta : A \rightarrow \mathbb{R}$ be a continuous argument function of a path connected set $A \subseteq \mathbb{C} \setminus \{0\}$. For each $p \in \mathbb{Z}$ also $\theta + 2\pi p$ is a continuous argument function of A , and these are the only such functions.*

Proof. For each $p \in \mathbb{Z}$ the function $\theta + 2\pi p : z \mapsto \theta(z) + 2\pi p$ is clearly continuous. It is an argument function of A because $e^{i(\theta(z)+2\pi p)} = e^{i\theta(z)}$. If $\theta_1 : A \rightarrow \mathbb{R}$ is an arbitrary continuous argument function of A , then $z = |z|e^{i\theta(z)} = |z|e^{i\theta_1(z)}$, and because $z \neq 0$ we get $e^{i(\theta_1(z)-\theta(z))} = 1$. Theorem 1.18 implies that $\theta_1(z) - \theta(z) \in 2\pi\mathbb{Z}$, hence $\theta_1 - \theta : A \rightarrow \mathbb{R}$ is a continuous function with image contained in $2\pi\mathbb{Z}$. The set $2\pi\mathbb{Z}$ being discrete, we get by Theorem 5.7 that $\theta_1 - \theta$ is constant, i.e. equal to $2\pi p_0$ for a $p_0 \in \mathbb{Z}$. \square

For a continuous curve $\gamma : [a, b] \rightarrow \mathbb{C} \setminus \{0\}$ we are interested in finding a *continuous argument function along the curve*, i.e. a continuous function $\theta : [a, b] \rightarrow \mathbb{R}$ such that

$$\theta(t) \in \arg \gamma(t) \quad \text{for } t \in [a, b]$$

or equivalently

$$\gamma(t) = |\gamma(t)|e^{i\theta(t)} \quad \text{for } t \in [a, b].$$

We first prove the existence of a continuous argument function in a special case.

Lemma 5.9. *Let $\gamma : [a, b] \rightarrow \mathbb{C}$ be a continuous curve contained in a disc $K(z_0, r) \subseteq \mathbb{C} \setminus \{0\}$. Then there exists a continuous argument function along the curve.*

Proof. The assumption $0 \notin K(z_0, r)$ means that $|z_0| \geq r$.

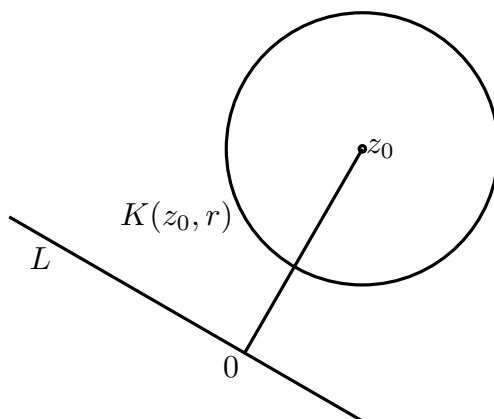

Figure 5.1

Let L be the line passing through 0 orthogonal to the line segment $[0, z_0]$. We can describe L as $L = \{se^{i\alpha} \mid s \in \mathbb{R}\}$ for a suitable choice of α . The disc $K(z_0, r)$ belongs to one of the two open half-planes, which remain when L is deleted from \mathbb{C} . We therefore have $K(z_0, r) \subseteq \mathbb{C}_\alpha$, and Arg_α is a continuous argument function of $K(z_0, r)$. The composed function $\theta(t) = \text{Arg}_\alpha(\gamma(t))$, $t \in [a, b]$ is a continuous argument function along γ . \square

Theorem 5.10. *Let $\gamma : [a, b] \rightarrow \mathbb{C} \setminus \{0\}$ be a continuous curve not passing through 0 . Then there exists a continuous argument function $\theta : [a, b] \rightarrow \mathbb{R}$ along γ and every continuous argument function along γ is given by $\theta(t) + 2p\pi$ for $p \in \mathbb{Z}$.*

Proof. We shall combine the paving lemma 5.2 with Lemma 5.9. By the paving lemma applied to γ there exists a subdivision $a = t_0 < t_1 < \dots < t_n = b$ and $r > 0$ such that (1) and (2) from Lemma 5.2 hold with $G = \mathbb{C} \setminus \{0\}$.

The first part of the curve $\gamma(t)$, $t \in [t_0, t_1]$ belongs to the disc $K(\gamma(t_0), r) \subseteq \mathbb{C} \setminus \{0\}$. By Lemma 5.9 there exists a continuous argument function $\theta_1 : [t_0, t_1] \rightarrow \mathbb{R}$ along $\gamma(t)$, $t \in [t_0, t_1]$. Similarly there exists a continuous argument function $\theta_2 : [t_1, t_2] \rightarrow \mathbb{R}$ along $\gamma(t)$, $t \in [t_1, t_2]$. Using that $\theta_1(t_1)$ and $\theta_2(t_1)$ are both arguments for $\gamma(t_1)$, there exists $p_1 \in \mathbb{Z}$ such that $\theta_1(t_1) = \theta_2(t_1) + 2p_1\pi$. This means that the function $\theta : [t_0, t_2] \rightarrow \mathbb{R}$ defined by

$$\theta(t) = \begin{cases} \theta_1(t), & t \in [t_0, t_1] \\ \theta_2(t) + 2p_1\pi, & t \in [t_1, t_2] \end{cases}$$

is a continuous argument function along $\gamma(t)$, $t \in [t_0, t_2]$.

Proceeding in the same way we can step by step prolong θ to $[t_2, t_3]$, $[t_3, t_4]$ etc., and finally we obtain a continuous argument function $\theta : [t_0, t_n] \rightarrow \mathbb{R}$ along γ .

If $\tilde{\theta} : [a, b] \rightarrow \mathbb{R}$ is another continuous argument function along γ , then $\tilde{\theta} - \theta$ is a continuous function on $[a, b]$ such that its image is contained in the

discrete set $2\pi\mathbb{Z}$. By Theorem 5.7 we infer that $\tilde{\theta} - \theta$ is constant on $[a, b]$, hence $\tilde{\theta}(t) = \theta(t) + 2\pi p$ for suitable $p \in \mathbb{Z}$. \square

Notice that a continuous argument function θ along γ is defined on the parameter interval $[a, b]$. The set γ^* of points on the curve is a closed and bounded subset of $\mathbb{C} \setminus \{0\}$ by Theorem A3. If γ^* has a continuous argument function θ_{γ^*} , then $\theta_{\gamma^*} \circ \gamma$ is a continuous argument function along γ , but it can happen that γ^* does not have a continuous argument function, as the next example indicates.

Example 5.11. Let $\gamma : [0, 4\pi] \rightarrow \mathbb{C} \setminus \{0\}$ be given by $\gamma(t) = e^{it}$. For t traversing $[0, 4\pi]$ the point $\gamma(t)$ traverses the unit circle twice counterclockwise. Note that $\gamma(t) = 1$ for $t = 0, 2\pi, 4\pi$. A continuous argument function along γ is $\theta(t) = t$, $t \in [0, 4\pi]$. The point 1 on the unit circle “gets” the arguments $0, 2\pi, 4\pi$ at the three moments where $\gamma(t) = 1$.

The set $\gamma^* = \{z \in \mathbb{C} \mid |z| = 1\}$ has *no* continuous argument function, cf. exc. 5.4.

Having done the preparations above we can now make two intuitive concepts precise.

Definition 5.12. Let $\gamma : [a, b] \rightarrow \mathbb{C} \setminus \{0\}$ be a continuous curve not passing through 0. The *variation of argument along γ* is the real number

$$\text{argvar}(\gamma) := \theta(b) - \theta(a),$$

where θ is an arbitrary continuous argument function along γ .

For a closed continuous curve $\gamma : [a, b] \rightarrow \mathbb{C} \setminus \{0\}$ the integer

$$\omega(\gamma, 0) := \frac{1}{2\pi} \text{argvar}(\gamma)$$

is called the *winding number* with respect to 0.

In the definition above the number $\theta(b) - \theta(a)$ does not depend on the choice of a continuous argument function along γ because another such function has the form $\tilde{\theta}(t) = \theta(t) + 2\pi p$ for suitable $p \in \mathbb{Z}$, hence

$$\tilde{\theta}(b) - \tilde{\theta}(a) = \theta(b) + 2\pi p - (\theta(a) + 2\pi p) = \theta(b) - \theta(a).$$

If γ is closed, i.e. $\gamma(a) = \gamma(b)$, then $\theta(a)$ and $\theta(b)$ are arguments of the same complex number $\gamma(a) = \gamma(b)$. Therefore $\theta(b) - \theta(a) = 2\pi p$ for a uniquely determined $p \in \mathbb{Z}$, and we have $\omega(\gamma, 0) = p$.

In the Example 5.11 we have $\text{argvar}(\gamma) = 4\pi$ and $\omega(\gamma, 0) = 2$.

If $\tau : [c, d] \rightarrow \mathbb{C} \setminus \{0\}$ is another parameterization of the oriented curve given by γ , i.e. $\tau \circ \varphi = \gamma$, where φ is a continuous and strictly increasing mapping of $[a, b]$ onto $[c, d]$, then clearly $\text{argvar}(\gamma) = \text{argvar}(\tau)$, but if the orientation is changed, then the variation of argument changes sign. In particular we have $\omega(-\gamma, 0) = -\omega(\gamma, 0)$ for a closed curve γ in $\mathbb{C} \setminus \{0\}$, where as usual $-\gamma$ denotes the reverse curve.

5.3. n 'th roots.

We recall that every complex number $z \neq 0$ has n different complex n 'th roots, $n = 1, 2, \dots$. If $z = re^{i\theta}$ with $r = |z|$, $\theta \in \mathbb{R}$, then these roots are given by the expressions

$$z_k = r^{1/n} e^{i\theta_k}, \quad \theta_k = \frac{\theta}{n} + k \frac{2\pi}{n}, \quad k = 0, 1, \dots, n-1.$$

We now define

$$\sqrt[n]{z} = \{z_k \mid k = 0, 1, \dots, n-1\}$$

and $\sqrt[n]{0} = 0$. The expression $\sqrt[n]{z}$ is not a complex function in the usual sense, because to every $z \in \mathbb{C}$ there is not attached a definite complex number as the n 'th root. To every $z \neq 0$ is attached a subset of \mathbb{C} consisting of the n roots z_k , $k = 0, 1, \dots, n-1$. This means that we can think of $\sqrt[n]{z}$ as a mapping of \mathbb{C} into the set $\mathcal{P}(\mathbb{C})$ of subsets of \mathbb{C} . We can call $\sqrt[n]{z}$ a *multi-valued function*. We need to consider a *branch of $\sqrt[n]{z}$* , i.e. a function $f : A \rightarrow \mathbb{C}$ defined on a set $A \subseteq \mathbb{C}$ such that $f(z) \in \sqrt[n]{z}$ for all $z \in A$. A branch of the n 'th root chooses one of the roots for each z in the set of definition A , similar to an argument function, which chooses an argument. If $f : A \rightarrow \mathbb{C}$ is a branch of $\sqrt[n]{z}$, then so is $z \mapsto f(z) \exp(2\pi ik/n)$ for each $k = 0, 1, \dots, n-1$.

The point 0 plays a special role and is called a *branch point* for $\sqrt[n]{z}$.

There is a certain ambiguity in the notation. You may be accustomed to $\sqrt{4} = 2$, but now we have defined $\sqrt{4} = \{\pm 2\}$. However, in most cases we continue to consider $\sqrt[n]{r}$ as a positive number when $r > 0$, and we do so in Theorem 5.13. Normally it will be clear from the context how the roots shall be considered.

Theorem 5.13. *Let $n = 1, 2, \dots$ be fixed. The function z^n is a bijection of the angular domain*

$$\left\{ z \in \mathbb{C} \setminus \{0\} \mid |\text{Arg } z| < \frac{\pi}{n} \right\}$$

onto \mathbb{C}_π . The inverse function

$$\rho_n(z) = \sqrt[n]{|z|} e^{i \frac{\text{Arg } z}{n}}$$

is a holomorphic branch of $\sqrt[n]{z}$ on \mathbb{C}_π .

Proof. It is easy to see that $z \rightarrow z^n$ is a bijection of the domains in question and the inverse function is ρ_n . Clearly, ρ_n is continuous because $\text{Arg} : \mathbb{C}_\pi \rightarrow]-\pi, \pi[$ is so, and since z^n is holomorphic, it follows by Remark 1.5 that ρ_n is holomorphic with

$$\rho_n'(z) = \frac{1}{n(\rho_n(z))^{n-1}} = \frac{1}{n}\rho_n(z)^{1-n}.$$

Using the inaccurate way of writing $\rho_n(z) = z^{\frac{1}{n}}$, the formula for the derivative can be written

$$\frac{d}{dz}z^{\frac{1}{n}} = \frac{1}{n}z^{\frac{1}{n}-1},$$

which is the usual formula, when we consider the function on $]0, \infty[$. \square

The Riemann surface of \sqrt{z} .

In the case of $n = 2$ we have two holomorphic branches $\pm \rho_2(z)$ of \sqrt{z} . They map \mathbb{C}_π onto the right (respectively left) open half-plane.

As model for the cut plane \mathbb{C}_π we take a piece of paper with a cut. The two edges of the cut appear as two boundaries, each of which is homeomorphic to the half-line $]-\infty, 0]$. The function ρ_2 has a natural continuation to these boundaries. The boundary of the second quadrant is mapped by ρ_2 onto $\{iy \mid y \geq 0\}$ and the boundary of the third quadrant is mapped onto $\{iy \mid y \leq 0\}$. Similarly, the branch $-\rho_2$ maps the boundaries of the cut plane onto the two imaginary half-axes interchanged.

We place two copies of the cut plane \mathbb{C}_π one above the other as two identical layers and we use the mapping ρ_2 on the upper layer and $-\rho_2$ on the lower layer. By glueing the upper edge of the upper layer to the lower edge of the lower layer, we see that ρ_2 and $-\rho_2$ agree on the half-line of glueing, such that we can consider the mappings together as a continuous function of the two layers. The image is the union of the right and left open half-planes with the half-axis $\{iy \mid y \geq 0\}$.

If we next glue the lower edge of the upper layer to the upper edge of the lower layer, we get a continuous extension of ρ_2 and $-\rho_2$ mapping the half-line of glueing onto $\{iy \mid y \leq 0\}$.

The second glueing cannot be realized in the 3-dimensional space, so we have to imagine an abstract surface with two layers, called the *Riemann surface* of \sqrt{z} .

Imagine that we have drawn unit circles in each layer. When moving along the unit circle in the upper layer starting at 1, we move to the lower layer after turning the angle π . After having followed the unit circle in the lower layer for an angle of 2π we move back to the upper layer again. By combining

ρ_2 and $-\rho_2$ on the Riemann surface as indicated above, we have realized \sqrt{z} as a bijection of the Riemann surface onto \mathbb{C} .

The branch point zero shall be omitted from the Riemann surface, if we want to consider it as a two-dimensional manifold.

Multi-valued functions can be realized on suitable Riemann surfaces, but we will not pursue this further in these notes.

5.4. The logarithm.

The natural logarithm $\ln :]0, \infty[\rightarrow \mathbb{R}$ is the inverse function of the exponential function $\exp : \mathbb{R} \rightarrow]0, \infty[$. The notation for the natural logarithm varies. In the literature we meet $\log r = \ln r = \log_e r$ for $r > 0$.

Because of the periodicity with period $2\pi i$ the complex exponential function does not have an inverse.

Using the formula $\exp(x+iy) = e^x e^{iy}$, we see that the exponential function maps the horizontal line $y = \alpha$ bijectively onto the half-line $\{r e^{i\alpha} \mid r > 0\}$, and it therefore maps every horizontal strip

$$\{z \in \mathbb{C} \mid a < \operatorname{Im} z \leq a + 2\pi\}$$

bijectionally onto $\mathbb{C} \setminus \{0\}$. In other words, given $z \in \mathbb{C} \setminus \{0\}$, there exist infinitely many solutions $w \in \mathbb{C}$ to the equation $\exp w = z$, and writing $w = u + iv$, we see that $e^u = |z|$, $v \in \arg z$. The set of solutions to the equation is therefore

$$\ln |z| + i \arg z = \{ \ln |z| + iv \mid v \in \arg z \},$$

and this set is denoted $\log z$. The value of $\log z$ corresponding to the principal argument for z is called the *principal logarithm* and is denoted $\operatorname{Log} z$, hence

$$\operatorname{Log} z = \ln |z| + i \operatorname{Arg} z. \quad (1)$$

The principal logarithm is the inverse function of the restriction of \exp to the strip $\{z \in \mathbb{C} \mid -\pi < \operatorname{Im} z \leq \pi\}$, hence

$$\exp(\operatorname{Log}(z)) = z, \quad z \in \mathbb{C} \setminus \{0\}, \quad \operatorname{Log}(\exp(z)) = z, \quad -\pi < \operatorname{Im} z \leq \pi.$$

For $r > 0$ we have $\ln r = \operatorname{Log} r$. Writing $\log r$ is ambiguous: It can be a real number or the infinite set $\ln r + 2\pi i\mathbb{Z}$. Unless it is clear from the context, one has to explain the precise meaning.

Theorem 5.14. *The principal logarithm*

$$\operatorname{Log} z = \ln |z| + i \operatorname{Arg} z$$

is holomorphic in the cut plane \mathbb{C}_π , cf. Section 5.2, and maps it bijectively onto the strip $\{w \in \mathbb{C} \mid -\pi < \text{Im } w < \pi\}$. The derivative is given by

$$\text{Log}'(z) = \frac{1}{z}, \quad z \in \mathbb{C}_\pi. \quad (2)$$

Proof. The principal logarithm is continuous on the domain of definition and the inverse function of \exp . Using that $\exp'(z) = \exp(z) \neq 0$, we get by Remark 1.5 that Log is holomorphic with $\text{Log}'(z) = 1/\exp(\text{Log } z) = 1/z$. \square

We can consider $\log z$ as a multi-valued function, and in analogy with the multi-valued function $\sqrt[n]{z}$ we need the concept of a branch of the logarithm.

Given a set $A \subseteq \mathbb{C} \setminus \{0\}$ we call a function $l: A \rightarrow \mathbb{C}$ a branch of the logarithm if $l(z) \in \log z$ for $z \in A$, i.e. if $\exp(l(z)) = z$ for $z \in A$. If α is an argument function of A , then $l(z) = \ln|z| + i\alpha(z)$ is a branch of the logarithm on A . If conversely l is a branch of the logarithm on A , then $\alpha = \text{Im } l$ is an argument function of A .

Summing up we have: $A \subseteq \mathbb{C} \setminus \{0\}$ has a continuous argument function if and only if there exists a continuous branch of the logarithm on A .

Fix $\alpha \in \mathbb{R}$. The restriction of the exponential function

$$\exp: \{z \in \mathbb{C} \mid \alpha - 2\pi < \text{Im } z < \alpha\} \rightarrow \mathbb{C}_\alpha = \mathbb{C} \setminus \{re^{i\alpha} \mid r \geq 0\}$$

is a continuous bijection, and the inverse mapping can be expressed by the argument function Arg_α of subsection 5.2

$$\text{Log}_\alpha z := \ln|z| + i \text{Arg}_\alpha(z),$$

which is continuous. By Remark 1.5 we see that Log_α is holomorphic in \mathbb{C}_α , and the derivative is

$$\frac{d}{dz} \text{Log}_\alpha z = \frac{1}{\exp(\text{Log}_\alpha z)} = \frac{1}{z}. \quad (3)$$

The function Log_α is a holomorphic branch of the logarithm in the cut plane \mathbb{C}_α , and in this domain it is a primitive of $1/z$. Notice that $\text{Log}_\pi = \text{Log}$ in \mathbb{C}_π .

This can be generalized:

Theorem 5.15. *Let $G \subseteq \mathbb{C} \setminus \{0\}$ be a simply connected domain, let $z_0 \in G$ and let $\theta_0 \in \arg(z_0)$. There exists a uniquely determined holomorphic branch $l_G: G \rightarrow \mathbb{C}$ of the logarithm such that $l_G(z_0) = \ln|z_0| + i\theta_0$, and it is a primitive of $1/z$. The function $\alpha_G = \text{Im } l_G$ is a continuous argument of G .*

Proof. Since G is simply connected, $1/z$ has a primitive $f \in \mathcal{H}(G)$ according to Theorem 3.5. A primitive being determined up to addition of a constant, we can assume that the primitive f is chosen such that $f(z_0) = \ln|z_0| + i\theta_0$.

The function $\varphi(z) = z \exp(-f(z))$ is holomorphic in G . Using $f'(z) = 1/z$, we find

$$\varphi'(z) = \exp(-f(z)) (1 - zf'(z)) = 0 \text{ for } z \in G, \quad \varphi(z_0) = 1.$$

This proves that $\varphi \equiv 1$, hence $\exp(f(z)) = z$ for $z \in G$, but this means that $l_G := f$ is a branch of the logarithm with the properties we want. Then $\alpha_G = \text{Im } l_G$ is a continuous argument of G .

If f_1 is another holomorphic branch of the logarithm in G , then $\exp(f(z)) = \exp(f_1(z)) = z$ for $z \in G$ and hence $\exp(f_1(z) - f(z)) = 1$. By Theorem 1.18 the continuous function $f_1 - f$ on G takes its values in the discrete set $i2\pi\mathbb{Z}$ and this forces the function to be constant, cf. Theorem 5.7, i.e. $f_1(z) = f(z) + i2p\pi, z \in G$ for a fixed integer p . If in addition we require that $f_1(z_0) = f(z_0)$, then necessarily $p = 0$. \square

Theorem 5.16. *The following power series expansion holds*

$$\text{Log}(1+z) = z - \frac{z^2}{2} + \frac{z^3}{3} - + \dots, \quad |z| < 1. \quad (4)$$

Proof. The function $f(z) = \text{Log}(1+z)$ is holomorphic in

$$G = \mathbb{C} \setminus]-\infty, -1],$$

and using $f'(z) = (1+z)^{-1}$, we see that $f^{(n)}(z) = (-1)^{n-1}(n-1)!(1+z)^{-n}$, showing that the Taylor series for f with centre 0 has the form

$$\sum_{n=1}^{\infty} \frac{(-1)^{n-1}}{n} z^n.$$

By Theorem 4.8 its sum is equal to $\text{Log}(1+z)$ in the largest open disc with centre 0 contained in G , and this is $K(0, 1)$. \square

Notice that the radius of convergence of the power series (4) is 1.

5.5. Powers.

Powers z^α , where $z, \alpha \in \mathbb{C}$, is defined for $z \neq 0$ by $z^\alpha = \exp(\alpha \log z)$, so in general z^α is an infinite set. As an example

$$i^i = e^{i \log i} = \{ e^{-\frac{\pi}{2} + 2p\pi} \mid p \in \mathbb{Z} \}.$$

This definition is an extension of n 'th roots $\sqrt[n]{z} = z^{1/n}$ defined in subsection 5.3.

We are interested in holomorphic branches of the multi-valued power function. If l_G is a holomorphic branch of the logarithm for a domain $G \subseteq \mathbb{C} \setminus \{0\}$, then $\exp(\alpha l_G(z))$ is a holomorphic branch of z^α with the derivative

$$\alpha l'_G(z) \exp(\alpha l_G(z)) = \frac{\alpha}{z} \exp(\alpha l_G(z)) = \alpha \exp((\alpha - 1)l_G(z)),$$

because $\exp(l_G(z)) = z$. This formula looks complicated, but we will just write it

$$\frac{d}{dz} z^\alpha = \alpha z^{\alpha-1},$$

by considering $z^\alpha, z^{\alpha-1}$ as holomorphic branches. This misuse of symbols is dangerous but practical, because then the formula looks like the well-known formula when $z > 0$.

Using that $\text{Log}(1+z)$ is a holomorphic branch for the cut plane $G = \mathbb{C} \setminus]-\infty, -1]$, we see that $z \mapsto \exp(\alpha \text{Log}(1+z))$ is a holomorphic branch of $(1+z)^\alpha$ in G . We shall now determine its power series with centre 0.

Theorem 5.17. The binomial series. Fix $\alpha \in \mathbb{C}$. For $|z| < 1$

$$(1+z)^\alpha = \exp(\alpha \text{Log}(1+z)) = \sum_{n=0}^{\infty} \binom{\alpha}{n} z^n,$$

where

$$\binom{\alpha}{0} = 1, \quad \binom{\alpha}{n} = \frac{\alpha(\alpha-1)\cdots(\alpha-n+1)}{n!} \text{ for } n \geq 1.$$

Proof. The largest open disc in G with centre 0 is $K(0,1)$. For $z \in G$ we find

$$\frac{d}{dz}(1+z)^\alpha = \alpha(1+z)^{\alpha-1},$$

hence by applying this n times

$$\left[\frac{d^n}{dz^n} (1+z)^\alpha \right]_{z=0} = \alpha(\alpha-1)\cdots(\alpha-n+1).$$

Using Theorem 4.8 the assertion follows. \square

Let $f \in \mathcal{H}(G)$ and assume that f is *zero-free*, i.e. $f(z) \neq 0$ for all $z \in G$. If $f(G)$ is contained in a simply connected domain $\Omega \subseteq \mathbb{C} \setminus \{0\}$, then it is easy to find holomorphic branches of $\log f$ and f^α , $\alpha \in \mathbb{C}$, namely $l_\Omega \circ f$ and $\exp(\alpha l_\Omega \circ f)$, where l_Ω is a holomorphic branch of the logarithm for Ω . Even if this condition on $f(G)$ is not fulfilled, it may be possible to find a holomorphic branch. For example $\exp(\mathbb{C}) = \mathbb{C} \setminus \{0\}$, and $z \mapsto z$ is a holomorphic branch of $\log e^z$.

The following is true:

Theorem 5.18. For a domain $G \subseteq \mathbb{C}$ the following conditions are equivalent:

- (a) G is simply connected.
- (b) For every $f \in \mathcal{H}(G)$ and every closed contour γ in G

$$\int_{\gamma} f(z) dz = 0.$$

- (c) Every $f \in \mathcal{H}(G)$ has a primitive.
- (d) Every zero-free $f \in \mathcal{H}(G)$ has a holomorphic logarithm, i.e. a function $l \in \mathcal{H}(G)$ such that $\exp l = f$.
- (e) Every zero-free $f \in \mathcal{H}(G)$ has a holomorphic square root, i.e. a function $g \in \mathcal{H}(G)$ such that $g^2 = f$.

Proof.

(a) \implies (b) is Cauchy's integral theorem.

(b) \implies (c) is contained in Theorem 2.13.

(c) \implies (d): If $f \in \mathcal{H}(G)$ is zero-free, then $f'/f \in \mathcal{H}(G)$ and by (c) it has a primitive l , which can be chosen such that $l(z_0) \in \log f(z_0)$ for given $z_0 \in G$. The function $\varphi = f \exp(-l)$ satisfies $\varphi' \equiv 0$, $\varphi(z_0) = 1$, hence $\varphi \equiv 1$, showing that $l \in \mathcal{H}(G)$ is a branch of the logarithm of f .

(d) \implies (e). If l is a holomorphic logarithm of the zero-free function $f \in \mathcal{H}(G)$, then $g = \exp(\frac{1}{2} l)$ is a holomorphic square root of f .

(e) \implies (a). This implication is difficult and the proof will not be given here. Theorem 5.18 is needed in the proof of the following famous theorem:

Theorem 5.19. Riemann's mapping theorem. Let G be a simply connected domain different from \mathbb{C} . Then there exists a holomorphic bijection $\varphi : G \rightarrow K(0, 1)$.

Remark 5.20. The proof of Riemann's mapping theorem and the implication (e) \implies (a) can be found in Rudin's book.

The inverse function φ^{-1} is also holomorphic (Theorem 1.4). Such a mapping is therefore called *biholomorphic*.

Using that (a) \iff (b), we see that Cauchy's integral theorem is valid in a domain if and only if the domain is simply connected.

Let G be a simply connected domain and let $f \in \mathcal{H}(G)$ be zero-free. Then there exists a holomorphic branch of f^α for every $\alpha \in \mathbb{C}$, namely $\exp(\alpha l)$, where l is a holomorphic branch of the logarithm of f .

Example 5.21. A holomorphic branch of Arcsin. Consider the domain

$$G = \mathbb{C} \setminus \{x \in \mathbb{R} \mid |x| \geq 1\},$$

i.e. the complex plane where we have removed the half-lines $] -\infty, -1]$ and $[1, \infty[$. It is star-shaped with respect to 0, in particular simply connected. The function $1/(1-z^2)$ is holomorphic in G (in fact holomorphic in $\mathbb{C} \setminus \{\pm 1\}$), and it never vanishes. By Theorem 5.18 it has a holomorphic square root in G , i.e. it is possible to view $1/\sqrt{1-z^2}$ as a holomorphic function in G . To find an expression for the function, we will use that $\varphi(z) = 1 - z^2$ maps G into $\mathbb{C}_\pi = \mathbb{C} \setminus]-\infty, 0]$. To see this we solve the equation $1 - z^2 = a$ with $-\infty < a \leq 0$ and find $z = \pm \sqrt{1-a}$ where $1-a \geq 1$, hence $z \notin G$. The composed function $\text{Log}(1-z^2)$ is well defined and holomorphic in G , and

$$\exp\left(-\frac{1}{2}\text{Log}(1-z^2)\right)$$

is a holomorphic branch of $1/\sqrt{1-z^2}$ in G . The function

$$-\exp\left(-\frac{1}{2}\text{Log}(1-z^2)\right)$$

is the other branch of the square root of $1/(1-z^2)$.

The function

$$\text{Arcsin } z = \int_{[0,z]} \frac{du}{\sqrt{1-u^2}}, \quad z \in G,$$

defined by integrating along the segment from 0 to z is holomorphic in G and a primitive of $1/\sqrt{1-z^2}$, cf. Theorem 2.13 and exc. 3.5. Besides we can integrate along an arbitrary path in G from 0 to z without changing the value of the integral.

In particular we have

$$\text{Arcsin } x = \int_0^x \frac{du}{\sqrt{1-u^2}} \quad \text{for } x \in]-1, 1[,$$

showing that the restriction of Arcsin to $] -1, 1[$ has the following properties

$$\text{Arcsin}'(x) = \frac{1}{\sqrt{1-x^2}} \quad \text{for } x \in]-1, 1[, \quad \text{Arcsin}(0) = 0,$$

hence Arcsin is the inverse function of $\sin :]-\frac{\pi}{2}, \frac{\pi}{2}[\rightarrow]-1, 1[$. It can be shown that Arcsin maps G bijectively onto the strip $\{z \in \mathbb{C} \mid -\frac{\pi}{2} < \text{Im } z < \frac{\pi}{2}\}$, and the restriction of the sine function to this strip is its inverse, cf. exc. 1.12.

Example 5.22. Elliptic functions. Let p be a polynomial of degree $n \geq 1$ having the zeros z_1, \dots, z_n . The function $1/p(z)$ is holomorphic in $G = \mathbb{C} \setminus \{z_1, \dots, z_n\}$, which is not simply connected. In order to find a holomorphic branch of $1/\sqrt{p(z)}$ we have to focus on a simply connected sub-domain of G , e.g. by removing some half-lines like in Example 5.21. Thereafter we can study primitives

$$F(z) = \int_{[z_0, z]} \frac{du}{\sqrt{p(u)}}$$

by integrating along paths from z_0 to z .

For polynomials p of degree 1, 2 it is known that the primitives can be expressed using logarithms and inverse trigonometric functions.

For polynomials of degree 3 and 4 the integrals are called *elliptic integrals*, because they appear if we calculate the length of arc of an ellipse. The elliptic integrals were studied by many of the famous mathematicians in the 1800'th and 1900'th century. A step forward for mankind appeared with the discoveries of Abel and Jacobi. In analogy with the fact that the sine function is the inverse function of the primitive

$$\int_0^x \frac{du}{\sqrt{1-u^2}},$$

they realized that it was more fruitful to study the inverse functions to the elliptic integrals. These inverse functions are called *elliptic functions*. The sine function is periodic in \mathbb{C} with period 2π . The elliptic functions have two complex periods which are linearly independent, if they are considered as vectors in the plane, typically a real period and a purely imaginary period.

5.6. More about winding numbers.

We shall find an expression for the variation of argument and the winding number as a path integral in the case where the continuous curve is a path, i.e. piecewise C^1 .

Theorem 5.23. *Let $\gamma : [a, b] \rightarrow \mathbb{C} \setminus \{0\}$ be a path avoiding 0. Then*

$$\int_{\gamma} \frac{dz}{z} = \ln \left| \frac{\gamma(b)}{\gamma(a)} \right| + i \operatorname{argvar}(\gamma). \quad (1)$$

If γ is closed, then the winding number with respect to 0 is given by

$$\omega(\gamma, 0) = \frac{1}{2\pi i} \int_{\gamma} \frac{dz}{z}. \quad (2)$$

Proof. We base the proof on the same ideas, which were used in Lemma 5.9 and Theorem 5.10, and we choose a subdivision $a = t_0 < t_1 < \dots < t_n = b$ and a number $r > 0$ such that (1) and (2) from the paving lemma hold for $G = \mathbb{C} \setminus \{0\}$. Let θ be a continuous argument function along γ , so in particular $\theta(t_k) \in \arg \gamma(t_k), k = 0, 1, \dots, n-1$. For each of the discs $K(\gamma(t_k), r)$ let

$$l_k(z) = \ln |z| + i \alpha_k(z), \quad k = 0, 1, \dots, n-1$$

be the unique holomorphic branch of the logarithm on $K(\gamma(t_k), r)$ with $\alpha_k(\gamma(t_k)) = \theta(t_k)$, cf. Theorem 5.15. Using that l_k is a primitive of $1/z$ in $K(\gamma(t_k), r)$, we find

$$\begin{aligned} \int_{\gamma} \frac{dz}{z} &= \sum_{k=0}^{n-1} \int_{\gamma|[t_k, t_{k+1}]} \frac{dz}{z} = \sum_{k=0}^{n-1} l_k(\gamma(t_{k+1})) - l_k(\gamma(t_k)) \\ &= \sum_{k=0}^{n-1} (\ln |\gamma(t_{k+1})| - \ln |\gamma(t_k)|) + i \sum_{k=0}^{n-1} (\alpha_k(\gamma(t_{k+1})) - \alpha_k(\gamma(t_k))) \\ &= \ln |\gamma(b)| - \ln |\gamma(a)| + i \sum_{k=0}^{n-1} \theta(t_{k+1}) - \theta(t_k). \end{aligned}$$

Here we have used that the terms in the first sum telescope.⁸ In the second sum we have used

$$\alpha_k(\gamma(t_{k+1})) - \alpha_k(\gamma(t_k)) = \arg \text{var}(\gamma|[t_k, t_{k+1}]) = \theta(t_{k+1}) - \theta(t_k),$$

which holds because $\alpha_k \circ \gamma$ and θ are two continuous argument functions along $\gamma|[t_k, t_{k+1}]$. The last sum is also telescoping, hence equal to $\theta(b) - \theta(a)$, i.e.

$$\int_{\gamma} \frac{dz}{z} = \ln \left| \frac{\gamma(b)}{\gamma(a)} \right| + i \arg \text{var}(\gamma).$$

If γ is closed, then $\gamma(a) = \gamma(b)$ and (1) is reduced to (2). \square

We shall now see how we can calculate the winding number of a closed curve just by following the curve by a finger.

We choose an oriented half-line L starting at 0. We follow the curve by a finger, marking the finitely many points A_0, \dots, A_{n-1} , where the curve crosses L . (We will only consider half-lines L , which cross the curve in a finite number of points, and we avoid cases, where L is a tangent to the curve).

To each of the points $A_k, k = 0, \dots, n-1$ we attach a *signature* $\text{sign}(A_k)$, which is 1, if we pass A_k moving counterclockwise (positive crossing), and -1 if we pass A_k moving clockwise (negative crossing).

With this notation we have:

⁸This expression is used for the terms in a sum of the form $\sum_{k=0}^n (a_{k+1} - a_k) = a_{n+1} - a_0$, probably because a marine telescope can be pulled out or folded up.

Theorem 5.24. *Let γ be a closed path in \mathbb{C} avoiding 0. The winding number with respect to 0 is given by*

$$\omega(\gamma, 0) = \sum_{k=0}^{n-1} \text{sign}(A_k), \quad (3)$$

which is the number of positive crossings of L minus the number of negative crossings of L .

Proof. We choose a parameterization $\varphi : [a, b] \rightarrow \mathbb{C} \setminus \{0\}$ of γ and a subdivision $a = t_0 < t_1 < \cdots < t_n = b$ such that $\varphi(a) = \varphi(b) = A_0$ and $\varphi(t_k) = A_k, k = 1, \dots, n-1$, where A_0, \dots, A_{n-1} are the points of crossing. It is convenient to define $A_n = A_0$. Let $\theta : [a, b] \rightarrow \mathbb{R}$ be a continuous argument function along γ .

The following assertion holds:

$$\theta(t_k) - \theta(t_{k-1}) = \pi(\text{sign}(A_k) + \text{sign}(A_{k-1})), \quad k = 1, \dots, n. \quad (4)$$

We prove it by considering the 4 possible combinations of signatures:

(i) $\text{sign}(A_{k-1}) = \text{sign}(A_k) = 1$.

In this case the path crosses L counterclockwise to time t_{k-1} , and in the time interval $]t_{k-1}, t_k[$ the path belongs to $\mathbb{C} \setminus L$ and for $t = t_k$ the path crosses L again counterclockwise. Using that the domain $\mathbb{C} \setminus L$ has the continuous argument function $\text{Arg}_\alpha(z)$, if α is such that $L = \{\text{re}^{i\alpha} \mid r \geq 0\}$, we find

$$\begin{aligned} \theta(t_k) - \theta(t_{k-1}) &= \lim_{\varepsilon \rightarrow 0^+} (\theta(t_k - \varepsilon) - \theta(t_{k-1} + \varepsilon)) \\ &= \lim_{\varepsilon \rightarrow 0^+} (\text{Arg}_\alpha(\varphi(t_k - \varepsilon)) - \text{Arg}_\alpha(\varphi(t_{k-1} + \varepsilon))) \\ &= \alpha - (\alpha - 2\pi) = 2\pi, \end{aligned}$$

hence both sides of (4) are equal to 2π .

(ii) $\text{sign}(A_{k-1}) = \text{sign}(A_k) = -1$.

In this case the path crosses L clockwise to time t_{k-1} and t_k , and for t between these numbers $\varphi(t)$ belongs to $\mathbb{C} \setminus L$. Using a continuity argument as above, we see that the variation of argument over $[t_{k-1}, t_k]$ is equal to -2π , hence both sides of (4) are equal to -2π .

(iii) $\text{sign}(A_{k-1}) = 1, \text{sign}(A_k) = -1$.

In this case the path crosses L counterclockwise to time t_{k-1} but clockwise to time t_k , and for t between these numbers $\varphi(t)$ belongs to $\mathbb{C} \setminus L$. Using a continuity argument as above, we see that the variation of argument over $[t_{k-1}, t_k]$ is equal to 0, hence both sides of (4) are equal to 0.

(iv) $\text{sign}(A_{k-1}) = -1, \text{sign}(A_k) = 1$.

This case is analogous to the case (iii).

We can now end the proof by remarking that

$$\begin{aligned} 2\pi\omega(\gamma, 0) &= \operatorname{argvar}(\gamma) = \theta(b) - \theta(a) = \sum_{k=1}^n (\theta(t_k) - \theta(t_{k-1})) \\ &= \pi \sum_{k=1}^n (\operatorname{sign}(A_k) + \operatorname{sign}(A_{k-1})) = 2\pi \sum_{k=0}^{n-1} \operatorname{sign}(A_k). \end{aligned}$$

□

In Figure 5.2 we have drawn two different half-lines L and L' . The first one has the crossings A_0, \dots, A_4 with the signatures $1, 1, -1, 1, 1$. The second one has the crossing A'_0, A'_1, A'_2 with the signatures $1, 1, 1$. Both countings yield the winding number 3.

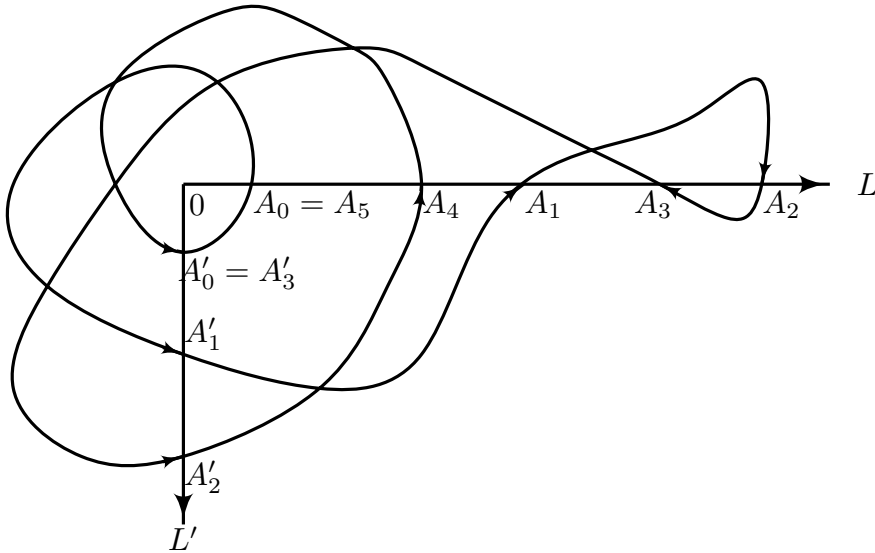

Figure 5.2

Let now $\gamma : [a, b] \rightarrow \mathbb{C}$ be an arbitrary closed continuous curve. The set $\gamma^* = \gamma([a, b])$ of points on the curve is closed and bounded, cf. Theorem A.3. The complement $G = \mathbb{C} \setminus \gamma^*$ is an open set. From topology it is known that an open set in the plane is the disjoint union of at most countably many domains called its (*connected*) *components*. For a proof of this see exc. 5.1. For $z \in G$ we define

$$\omega(\gamma, z) = \omega(\gamma - z, 0),$$

where $\gamma - z : [a, b] \rightarrow \mathbb{C}$ is the curve $t \mapsto \gamma(t) - z$, which does not pass through 0. The integer $\omega(\gamma, z)$ is called the *winding number with respect to* z . The winding number thus defines a mapping $\omega(\gamma, \cdot) : G \rightarrow \mathbb{Z}$.

Example 5.25. For $\gamma : [0, 2\pi] \rightarrow \mathbb{C}$ given by $\gamma(t) = e^{it}$ we have $\gamma^* = \{z \in \mathbb{C} \mid |z| = 1\}$ and $G = \mathbb{C} \setminus \gamma^*$ consists of two disjoint domains $\mathbb{D} = \{z \in \mathbb{C} \mid |z| < 1\}$ and $\Omega = \{z \in \mathbb{C} \mid |z| > 1\}$. We find $\omega(\gamma, z) = 1$ for $z \in \mathbb{D}$ and $\omega(\gamma, z) = 0$ for $z \in \Omega$.

Example 5.26. In Figure 5.3 the open set $G = \mathbb{C} \setminus \gamma^*$ consists of 8 domains, in each of which we have written the winding number with respect to any of its points. The winding number with respect to a point z has been calculated by the method of Theorem 5.24 by considering an oriented half-line emanating from z .

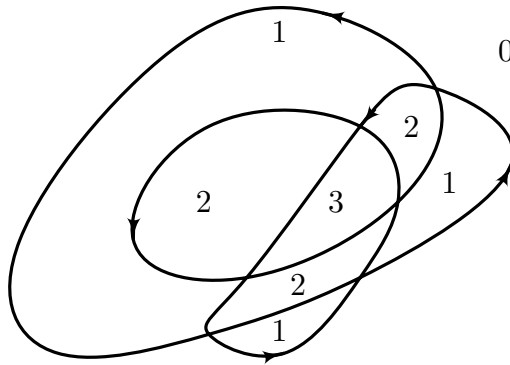

Figure 5.3

For a closed path γ we have

$$\omega(\gamma, z_0) = \frac{1}{2\pi i} \int_{\gamma} \frac{dz}{z - z_0}, \quad z_0 \in \mathbb{C} \setminus \gamma^*. \quad (5)$$

In fact, using a parameterization $\gamma(t)$, $t \in [a, b]$ we find

$$\begin{aligned} \omega(\gamma, z_0) &= \omega(\gamma - z_0, 0) = \frac{1}{2\pi i} \int_{\gamma - z_0} \frac{dz}{z} = \frac{1}{2\pi i} \int_a^b \frac{\gamma'(t)}{\gamma(t) - z_0} dt \\ &= \frac{1}{2\pi i} \int_{\gamma} \frac{dz}{z - z_0}. \end{aligned}$$

We shall now see that the situation of Example 5.26 is a general one:

Theorem 5.27. *Let $\gamma : [a, b] \rightarrow \mathbb{C}$ be a closed continuous curve. The winding number $\omega(\gamma, \cdot) : \mathbb{C} \setminus \gamma^* \rightarrow \mathbb{Z}$ is constant in each of the components of $\mathbb{C} \setminus \gamma^*$.*

Proof. We only give the proof in the case where γ is a path, i.e. piecewise C^1 . For $z_0 \in \mathbb{C} \setminus \gamma^*$ we choose $r > 0$ such that $K(z_0, 2r) \subseteq \mathbb{C} \setminus \gamma^*$. For $z_1 \in K(z_0, r)$ we have $|z_1 - \gamma(t)| \geq r$ for each $t \in [a, b]$, hence

$$\begin{aligned} \omega(\gamma, z_1) - \omega(\gamma, z_0) &= \frac{1}{2\pi i} \int_{\gamma} \left(\frac{1}{z - z_1} - \frac{1}{z - z_0} \right) dz \\ &= \frac{z_1 - z_0}{2\pi i} \int_{\gamma} \frac{dz}{(z - z_1)(z - z_0)}. \end{aligned}$$

By the estimation lemma 2.8 we get

$$|\omega(\gamma, z_1) - \omega(\gamma, z_0)| \leq \frac{|z_1 - z_0|}{2\pi r^2} L(\gamma),$$

showing that $\omega(\gamma, \cdot)$ is continuous at the point z_0 .

Let now G be a component of $\mathbb{C} \setminus \gamma^*$. Using that G is path connected, we infer from Theorem 5.7 that $\omega(\gamma, z)$ is constant for $z \in G$. \square

Exercises for §5

5.1. Let $G \subseteq \mathbb{C}$ be an open set and define a relation \sim in G by

$$\forall P, Q \in G : P \sim Q \iff P \text{ can be connected to } Q \text{ by a staircase line} \\ \text{belonging to } G$$

Prove that \sim is an equivalence relation, i.e. has the properties

$$(i) P \sim P \quad (ii) P \sim Q \implies Q \sim P \quad (iii) P \sim Q \wedge Q \sim R \implies P \sim R$$

For $P \in G$ define $[P] = \{Q \in G \mid P \sim Q\}$.

Prove that $[P]$ is a domain for every $P \in G$.

Prove that if $[P_1] \cap [P_2] \neq \emptyset$, then $[P_1] = [P_2]$.

The sets $[P]$, $P \in G$ are called the (*connected*) *components* of G . Give examples of open sets $G \subseteq \mathbb{C}$, where the number of components is $n = 1, 2, \dots, \infty$.

Prove that the number of components is countable.

5.2. Defining the sum of two sets $A, B \subseteq \mathbb{C}$ by

$$A + B = \{a + b \mid a \in A, b \in B\},$$

prove that for $z_1, z_2 \in \mathbb{C} \setminus \{0\}$

$$\arg(z_1 z_2) = \arg z_1 + \arg z_2, \\ \log(z_1 z_2) = \log z_1 + \log z_2.$$

Prove that if $\operatorname{Re} z_1 > 0$ and $\operatorname{Re} z_2 > 0$, then

$$\operatorname{Arg}(z_1 z_2) = \operatorname{Arg} z_1 + \operatorname{Arg} z_2, \\ \operatorname{Log}(z_1 z_2) = \operatorname{Log} z_1 + \operatorname{Log} z_2,$$

and show by examples that the two last equations do not hold for arbitrary $z_1, z_2 \in \mathbb{C} \setminus \{0\}$.

5.3. Prove that $\ln(x^2 + y^2)$ is harmonic in $\mathbb{R}^2 \setminus \{(0, 0)\}$ and that $\operatorname{Arctan} \frac{y}{x}$ is harmonic in $\{(x, y) \in \mathbb{R}^2 \mid x > 0\}$.

5.4. Prove that the set $\mathbb{T} = \{z \in \mathbb{C} \mid |z| = 1\}$ does not have a continuous argument function.

Hint. Assume that $\theta : \mathbb{T} \rightarrow \mathbb{R}$ is a continuous argument function with $\theta(1) = 0$. Prove that $\text{Arg}(z) = \theta(z)$ for $z \in \mathbb{T} \cap \mathbb{C}_\pi$. Use this to determine the limit of $\theta(z)$ for $z = x + iy \in \mathbb{T}$ approaching -1 via $y > 0$ and via $y < 0$.

5.5. Let $\gamma : [a, b] \rightarrow \mathbb{C} \setminus \{0\}$, $\delta : [b, c] \rightarrow \mathbb{C} \setminus \{0\}$ be continuous curves with $\gamma(b) = \delta(b)$, hence $\gamma \cup \delta$ makes sense. Prove that

$$\text{argvar}(\gamma \cup \delta) = \text{argvar}(\gamma) + \text{argvar}(\delta).$$

5.6. Calculate $\text{Arg} z$ and $\text{Log} z$ for the following values of $z \in \mathbb{C}$:

$$1 + i, \quad -\sqrt{3} + i, \quad (\sqrt{3} + i)^{2001}.$$

5.7. Let $\gamma_a : [0, 1] \rightarrow \mathbb{C} \setminus \{0\}$ be defined by $\gamma_a(t) = e^{ita}$, where $a \in \mathbb{R}$. Determine $\text{argvar}(\gamma_a)$. Prove that γ_a is closed if and only if $a = 2\pi p$, $p \in \mathbb{Z}$, and prove that $\omega(\gamma_a, 0) = p$ when $a = 2\pi p$, $p \in \mathbb{Z}$.

5.8. Let $0 < \alpha < 1$. Determine the image of the cut plane $\mathbb{C}_\pi = \mathbb{C} \setminus \{x \in \mathbb{R} \mid x \leq 0\}$ under the holomorphic branch of $z^\alpha = \exp(\alpha \text{Log} z)$.

Prove that $\text{Arg}(z^\alpha) = \alpha \text{Arg}(z)$, $|z^\alpha| = |z|^\alpha$ for $z \in \mathbb{C}_\pi$.

5.9. Let $G \subseteq \mathbb{C}$ be open and assume that $f \in \mathcal{H}(G)$ is zero-free. Prove that $\ln |f|$ is a harmonic function in G .

5.10. Prove that $\cos \sqrt{z}$ can be considered as a well-defined function from \mathbb{C} to \mathbb{C} . Prove that this function is holomorphic and determine its power series with centre 0.

5.11. For $n \geq 2$, $a \in \mathbb{C}$ and $\alpha \in \mathbb{R}$ we consider the half-lines

$$L_k = \left\{ a + r e^{i(\alpha + \frac{k2\pi}{n})} \mid r \geq 0 \right\}, \quad k = 0, 1, \dots, n-1,$$

dividing $\mathbb{C} \setminus \{a\}$ in n angular domains

$$V_k = \left\{ z = a + r e^{i\theta} \mid r > 0, \alpha + 2\pi \frac{k-1}{n} < \theta < \alpha + \frac{2\pi k}{n} \right\},$$

$k = 1, \dots, n$. Make a sketch of these half-lines and angular domains. Prove that $z \mapsto (z - a)^n$ maps each V_k bijectively onto $\mathbb{C}_{n\alpha}$ and find the corresponding inverse function.

5.12. Let $\sum_{n=0}^{\infty} a_n z^n, \sum_{n=0}^{\infty} b_n z^n$ denote two power series, both assumed to be absolutely convergent for $|z| < \rho$.

1°. Multiply the series by multiplying each term in one of the series by each term in the other and collect the terms having the same factor $z^n, n = 0, 1, 2, \dots$. Prove that this leads to the power series

$$a_0 b_0 + (a_0 b_1 + a_1 b_0)z + (a_0 b_2 + a_1 b_1 + a_2 b_0)z^2 + \dots,$$

or in more compact form

$$\sum_{n=0}^{\infty} c_n z^n, \text{ where } c_n = \sum_{k=0}^n a_k b_{n-k}, n = 0, 1, \dots$$

We call the power series $\sum_{n=0}^{\infty} c_n z^n$ the *Cauchy multiplication* of the given power series.

2°. Prove that $\sum_{n=0}^{\infty} c_n z^n$ is absolutely convergent for $|z| < \rho$ and for these z

$$\sum_{n=0}^{\infty} c_n z^n = \left(\sum_{n=0}^{\infty} a_n z^n \right) \left(\sum_{n=0}^{\infty} b_n z^n \right).$$

Hint to 2°: Explain that the function $f(z) = \left(\sum_{n=0}^{\infty} a_n z^n \right) \left(\sum_{n=0}^{\infty} b_n z^n \right)$ is holomorphic in $K(0, \rho)$, and prove using exc. 1.16 that

$$\frac{f^{(n)}(0)}{n!} = \sum_{k=0}^n a_k b_{n-k}.$$

3°. Using the Cauchy multiplication of two copies of the binomial series ($\alpha \in \mathbb{C}$)

$$(1+z)^\alpha = \sum_{n=0}^{\infty} \binom{\alpha}{n} z^n, |z| < 1,$$

prove that

$$\binom{\alpha + \beta}{n} = \sum_{k=0}^n \binom{\alpha}{k} \binom{\beta}{n-k},$$

where $\alpha, \beta \in \mathbb{C}, n = 0, 1, \dots$

5.13. Let γ be a closed path in $\{z \in \mathbb{C} \mid |z| \geq r\}$. Prove that $\omega(\gamma, z)$ is constant for $z \in K(0, r)$.

5.14. Verify that the winding numbers are as indicated in Example 5.26.

5.15. Let G be an open path connected subset of \mathbb{C} and let $P \subset G$ be discrete in G .

1°. Let $\gamma : [a, b] \rightarrow G$ be a continuous curve in G . Prove that $\gamma^* \cap P$ is a finite set.

2°. Let L be a staircase line in G with end points $a, b \in G \setminus P$ and assume that the set $L \cap P$, which is finite by 1°, is written $\{p_1, \dots, p_n\}$. Prove that there exists a continuous curve from a to b in $G \setminus P$ consisting of line segments and circular arcs.

3°. Conclude that $G \setminus P$ is path connected.

5.16. Prove that

$$\lim_{n \rightarrow \infty} \left(1 + \frac{z}{n}\right)^n = \exp(z)$$

locally uniformly for $z \in \mathbb{C}$ by using Log . Compare with exc. 1.18.

Hint. Fix a closed and bounded subset K in \mathbb{C} . Prove that $n \text{Log}(1 + z/n)$ is defined for $z \in K$ if n is sufficiently big and converges to z uniformly on K .

§6. Zeros and isolated singularities

A C^∞ -function on the real axis can be zero on an interval without being identically zero. The following classical example is due to Cauchy

$$f(x) = \begin{cases} e^{-1/x}, & x > 0 \\ 0, & x \leq 0. \end{cases}$$

For holomorphic functions such a behaviour is not possible: Every zero a of a holomorphic function f is isolated in the sense that there are no other zeros in a sufficiently small disc $K(a, r)$, unless of course f is identically zero. This makes it possible to prove an identity theorem for holomorphic functions: If two holomorphic functions in a domain are equal on a tiny set (to be made precise), then they are identical. This result has far reaching consequences.

We will discuss isolated singularities for holomorphic functions and we will classify them in one of three types: Removable singularities, poles and essential singularities. Around an isolated singularity a holomorphic function can be developed in a kind of power series which includes negative powers. It is called the Laurent series of the function. Quotients of holomorphic functions are called meromorphic. They have poles at points where the denominator is zero. From an algebraic point of view we can consider the set $\mathcal{M}(G)$ of meromorphic functions as a field, namely the quotient field of the ring $\mathcal{H}(G)$ of holomorphic functions.

6.1. Zeros.

We recall that if a polynomial p of degree ≥ 1 has a zero (= root) a , i.e. if $p(a) = 0$, then the polynomial can be factorized $p(z) = (z - a)^n q(z)$, where q is a polynomial with $q(a) \neq 0$ and $n \geq 1$ denotes the multiplicity or order of the zero.

We shall extend this elementary result to holomorphic functions.

Theorem 6.1. *Let f be holomorphic in a domain G and assume that f is not identically 0. If $a \in G$ is a zero of f , i.e. if $f(a) = 0$, then there exists a unique natural number n and a unique function $g \in \mathcal{H}(G)$ with $g(a) \neq 0$ such that*

$$f(z) = (z - a)^n g(z) \text{ for } z \in G. \quad (1)$$

The number n is called the *multiplicity* or *order* of the zero.

Proof. We first prove the existence of the factorization (1).

Let $K(a, \rho)$ denote the biggest open disc centered at a and contained in G . By Theorem 4.8 we have

$$f(z) = \sum_{k=0}^{\infty} \frac{f^{(k)}(a)}{k!} (z - a)^k, \quad z \in K(a, \rho). \quad (2)$$

Assuming $f^{(k)}(a) = 0$ for all $k \geq 0$, we get $f(z) = 0$ for all $z \in K(a, \rho)$, and we see below that f is identically zero in G in contradiction with the assumption.

Fix $z_0 \in G$ and choose a continuous curve $\gamma : [0, 1] \rightarrow G$ connecting $\gamma(0) = a$ with $\gamma(1) = z_0$. By the paving lemma 5.2 there exist finitely many points $0 = t_0 < t_1 < \dots < t_n = 1$ and a number $r > 0$ such that (1) and (2) from the paving lemma hold. In particular we have $K(\gamma(0), r) = K(a, r) \subseteq G$, hence $K(a, r) \subseteq K(a, \rho)$. Moreover, $\gamma(t_1) \in K(a, r)$ and f is identically 0 in $K(a, \rho)$, hence $f^{(k)}(\gamma(t_1)) = 0$ for all $k \geq 0$. By Theorem 4.8 we get that f is identically 0 in $K(\gamma(t_1), r)$. In the same way we deduce successively that f is identically 0 in all the discs $K(\gamma(t_k), r)$ and in particular that $f(z_0) = 0$.

Having proved that our assumption leads to a contradiction, we see that there exists a smallest number $n \geq 1$ such that $f^{(n)}(a) \neq 0$, hence $f^{(k)}(a) = 0$ for $k = 0, 1, \dots, n-1$. By equation (2) we then get

$$f(z) = \sum_{k=n}^{\infty} \frac{f^{(k)}(a)}{k!} (z-a)^k = (z-a)^n \sum_{k=0}^{\infty} \frac{f^{(k+n)}(a)}{(k+n)!} (z-a)^k \quad (3)$$

for $z \in K(a, \rho) \subseteq G$. The function

$$g(z) = \begin{cases} \frac{f(z)}{(z-a)^n} & \text{for } z \in G \setminus \{a\}, \\ \sum_{k=0}^{\infty} \frac{f^{(k+n)}(a)}{(k+n)!} (z-a)^k & \text{for } z \in K(a, \rho), \end{cases}$$

is well-defined on account of (3) and holomorphic in G . Moreover,

$$f(z) = (z-a)^n g(z) \text{ for } z \in G, \quad g(a) = f^{(n)}(a)/n! \neq 0,$$

which is a factorization of the type we want.

To prove the uniqueness of the factorization (1), assume that

$$f(z) = (z-a)^{n_1} g_1(z) = (z-a)^{n_2} g_2(z), \quad z \in G \quad (4)$$

where $g_1(a) \neq 0$, $g_2(a) \neq 0$. By reasons of symmetry we can assume that $n_1 \geq n_2$. By (4) we then get

$$(z-a)^{n_1-n_2} g_1(z) = g_2(z), \quad z \in G \setminus \{a\},$$

and by a continuity argument this equation also holds for $z = a$. Since we know that $g_2(a) \neq 0$ we get $n_1 = n_2$, hence $g_1(z) = g_2(z)$ for all $z \in G$. \square

The theorem shows that the order of a zero a of $f \not\equiv 0$ is the biggest natural number n , for which there exists a factorization $f(z) = (z-a)^n g(z)$ with $g \in \mathcal{H}(G)$. If $f(a) \neq 0$, it is convenient to say that f has a zero of order 0 in a . The order of the zero a of f is denoted $\text{ord}(f, a)$. A zero of order 1 is also called a *simple* zero, and a zero of order 2 is called a *double* zero.

From the proof of Theorem 6.1 we see the following:

Corollary 6.2. *Let f be holomorphic in a domain G and assume that f is not identically 0. For a zero $a \in G$ the order n is characterized by the equations*

$$f(a) = f'(a) = \cdots = f^{(n-1)}(a) = 0, \quad f^{(n)}(a) \neq 0.$$

Theorem 6.3. *Let f be holomorphic in a domain G and assume that f is not identically 0.*

Every zero a of f is isolated in the sense that there exists $r > 0$ such that $f(z) \neq 0$ for $z \in K'(a, r)$.

The set $Z(f)$ of zeros of f is discrete in G and in particular $Z(f)$ is countable.

Proof. Let $f(z) = (z-a)^n g(z)$ be a factorization where $g \in \mathcal{H}(G)$ is such that $g(a) \neq 0$. Since g is continuous, there exists $r_a > 0$ such that $|g(z) - g(a)| < |g(a)|$ for $z \in K(a, r_a) \subseteq G$, hence $g(z) \neq 0$ for $z \in K(a, r_a)$. This shows that $f(z) \neq 0$ for $z \in K'(a, r_a)$.

We shall now prove that $Z(f)$ has no accumulation points in G . We have just proved that the points $a \in Z(f)$ are not accumulation points of $Z(f)$.

Assuming that $z_0 \in G \setminus Z(f)$ is an accumulation point of $Z(f)$, there exists a sequence of points (a_n) from $Z(f)$ such that $a_n \rightarrow z_0$. By continuity of f we then get $f(z_0) = 0$, contradicting $z_0 \notin Z(f)$.

Having proved that the assumption was wrong, we know that $Z(f)$ is discrete in G . By Theorem 5.6 it is countable. \square

The converse is also true: If $P \subseteq G$ is an arbitrary discrete set in G , then there exists $f \in \mathcal{H}(G)$ such that $Z(f) = P$. It is even possible to assign multiplicities $n_p \in \mathbb{N}$ to each $p \in P$ and choose f such that $\text{ord}(f, p) = n_p$ for each $p \in P$. We skip the proof which depends on a general theory of Weierstrass about factorization of entire functions. See Rudin's book for details.

Example 6.4. The exponential function is zero-free in \mathbb{C} . For the sine function we have $Z(\sin) = \pi\mathbb{Z}$, which is a countable discrete subset of \mathbb{C} . The function $\sin(1/z)$ is holomorphic in $\mathbb{C} \setminus \{0\}$ and has the zeros $(p\pi)^{-1}$, $p \in \mathbb{Z} \setminus \{0\}$, which have 0 as accumulation point. However, within $\mathbb{C} \setminus \{0\}$ the zero set has no accumulation points.

In analogy to the results about zeros of $f \in \mathcal{H}(G)$, let us fix $\lambda \in \mathbb{C}$ and consider the set $\{z \in G \mid f(z) = \lambda\}$. This set is either equal to \emptyset , G or a countable discrete subset of G . This is simply because the set in question is equal to $Z(f - \lambda)$.

For these results it is important that G is path connected. If $G = K(0, 1) \cup K(2, 1)$, we can define $f \in \mathcal{H}(G)$ by setting $f = 0$ in one disc and $f = 1$ in the other.

Theorem 6.5. (The identity theorem for holomorphic functions).

If two holomorphic functions f, g in a domain G agree on a set $A \subseteq G$ having an accumulation point in G , then $f(z) = g(z)$ for all $z \in G$.

Proof. The zero set $Z(f - g)$ is not discrete in G since it contains A , but then $f - g$ is identically zero in G . \square

A typical application of the theorem is the following: Assume that $\mathbb{R} \cap G \neq \emptyset$ and that $f(x) = g(x)$ for all $x \in \mathbb{R} \cap G$. Since $\mathbb{R} \cap G$ contains a non-degenerate interval, it has accumulation points in G , hence $f = g$.

Example 6.6. As an application of the identity theorem it is possible to prove that all the usual trigonometric formulas known for real values of the argument also hold for complex values of the argument, provided the expressions are holomorphic.

As an example $\sin^2 z + \cos^2 z = 1$ for all $z \in \mathbb{C}$. The expressions on the left and right of the equality sign are holomorphic in \mathbb{C} and agree for real numbers.

Let $f, g \in \mathcal{H}(G)$ and assume that $f(a) = g(a) = 0$ for some $a \in G$. It is not directly possible to determine

$$\lim_{z \rightarrow a} \frac{f(z)}{g(z)},$$

because formally we get $0/0$. L'Hospital's rule from real analysis gets a particularly simple form for holomorphic functions:

Theorem 6.7. (L'Hospital's rule). Assume that $f, g \in \mathcal{H}(G)$ are not identically zero in a disc around $a \in G$.

The limit

$$\lim_{z \rightarrow a} \frac{f(z)}{g(z)}$$

exists if and only if $\text{ord}(f, a) \geq \text{ord}(g, a)$.

If this condition is fulfilled, then

$$\lim_{z \rightarrow a} \frac{f(z)}{g(z)} = \frac{f^{(q)}(a)}{g^{(q)}(a)},$$

where $q = \text{ord}(g, a)$ and hence $g^{(q)}(a) \neq 0$.

Proof. Let $p = \text{ord}(f, a)$, $q = \text{ord}(g, a)$ and let $f_1, g_1 \in \mathcal{H}(G)$ with $f_1(a) \neq 0$, $g_1(a) \neq 0$ such that

$$f(z) = (z - a)^p f_1(z), \quad g(z) = (z - a)^q g_1(z).$$

If $p \geq q$ we find

$$\lim_{z \rightarrow a} \frac{f(z)}{g(z)} = \lim_{z \rightarrow a} (z - a)^{p-q} \frac{f_1(z)}{g_1(z)} = \begin{cases} 0, & p > q \\ \frac{f_1(a)}{g_1(a)}, & p = q, \end{cases}$$

but this expression is $f^{(q)}(a) / g^{(q)}(a)$ because $g^{(q)}(a) = q!g_1(a)$,

$$f^{(q)}(a) = \begin{cases} 0, & p > q \\ q!f_1(a), & p = q. \end{cases}$$

If $p < q$ we find

$$(z - a)^{q-p} \frac{f(z)}{g(z)} = \frac{f_1(z)}{g_1(z)} \rightarrow \frac{f_1(a)}{g_1(a)} \neq 0.$$

Therefore $f(z)/g(z)$ can not have a limit for $z \rightarrow a$. In fact, if the limit existed then the left hand side would approach 0 for $z \rightarrow a$ because of the factor $(z - a)^{q-p}$. \square

6.2. Isolated singularities.

Definition 6.8. A point $a \in \mathbb{C}$ is called an *isolated singularity* of a function f , if there exists a radius $r > 0$ such that $f \in \mathcal{H}(K'(a, r))$. If f can be given a complex value at a such that f becomes differentiable at a (and hence holomorphic in $K(a, r)$), then the singularity is said to be *removable*.

As an example where isolated singularities naturally appear, assume that $f \in \mathcal{H}(G)$ is not identically zero in the domain G . The reciprocal function $1/f$ is holomorphic in $G \setminus Z(f)$, and all points $a \in Z(f)$ are isolated singularities of $1/f$. The point 0 is an isolated singularity of $1/z$, and the integers are isolated singularities of $1/\sin(\pi z)$.

In case of a being a removable singularity of f , the only possible value of f at a making f differentiable at a is $\lim_{z \rightarrow a} f(z)$, so a necessary condition for a to be removable is that the limit exists. That this condition is also sufficient is not at all clear, but it will follow from the next theorem, because if f has a limit for $z \rightarrow a$, then f is bounded in a sufficiently small punctured disc $K'(a, r)$.

Theorem 6.9 (Riemann). Assume that $f \in \mathcal{H}(K'(a, r))$ is bounded in $K'(a, r)$. Then f has a removable singularity at a .

Proof. We define $h(a) = 0$ and $h(z) = (z - a)^2 f(z)$ for $z \in K'(a, r)$. Then h is clearly holomorphic in $K'(a, r)$ and for $z \in K'(a, r)$ we have

$$\frac{h(z) - h(a)}{z - a} = (z - a)f(z),$$

which has the limit 0 for $z \rightarrow a$ because f is assumed to be bounded in the punctured disc.

This proves that $h \in \mathcal{H}(K(a, r))$ and $h'(a) = 0$. By Theorem 6.1 and Corollary 6.2 there exists $g \in \mathcal{H}(K(a, r))$ such that $h(z) = (z - a)^2 g(z)$ for $z \in K(a, r)$. This shows that $g(z) = f(z)$ for $z \in K'(a, r)$ and giving f the value $g(a)$ for $z = a$, then $f(=g)$ is differentiable at a , i.e., a is a removable singularity of f . \square

Notice that the boundedness condition of Theorem 6.9 implies the existence of the limit $\lim_{z \rightarrow a} f(z)$. This is quite remarkable.

The function $\sin z/z$ has a removable singularity for $z = 0$ because

$$\lim_{z \rightarrow 0} \frac{\sin z}{z} = 1.$$

If f has an isolated singularity at $z = a$ and the singularity is not removable, then the images $f(K'(a, r))$ are unbounded sets regardless of how small r is. In particular $f(z)$ does not have a limit for $z \rightarrow a$. It is natural to examine whether $(z - a)^m f(z)$ has a removable singularity for $m \in \mathbb{N}$ sufficiently big. If this is the case a is called a pole.

Definition 6.10. An isolated singularity a is called a *pole of order* $m \in \mathbb{N}$ of f , if $(z - a)^m f(z)$ has a limit for $z \rightarrow a$ and

$$\lim_{z \rightarrow a} (z - a)^m f(z) \neq 0.$$

A pole of order 1 is called a *simple pole*.

The function $f(z) = c/(z - a)^m$, where $c \neq 0, m = 1, 2, \dots$, has a pole of order m for $z = a$. The expression $(z - a)^m f(z)$ is constant equal to c and has in particular the limit c for $z \rightarrow a$.

The order of a pole a is uniquely determined. In fact, if

$$\lim_{z \rightarrow a} (z - a)^m f(z) = c \neq 0,$$

then $\lim_{z \rightarrow a} (z - a)^k f(z) = 0$ for $k > m$, while $(z - a)^k f(z)$ does not have a limit for $z \rightarrow a$ when $k < m$. Notice also that if a is a pole of order $m \geq 1$, then $|f(z)| \rightarrow \infty$ for $z \rightarrow a$, because $|z - a|^m |f(z)| \rightarrow |c|$.

Assume that $f \in \mathcal{H}(G \setminus \{a\})$ has a pole of order m at the point $a \in G$. The function

$$g(z) = \begin{cases} (z - a)^m f(z), & z \in G \setminus \{a\}, \\ \lim_{z \rightarrow a} (z - a)^m f(z), & z = a, \end{cases}$$

is holomorphic in G , hence has a power series

$$g(z) = \sum_{n=0}^{\infty} a_n (z - a)^n$$

in the largest open disc $K(a, \rho) \subseteq G$. For $z \in K'(a, \rho)$ we then find

$$f(z) = \frac{a_0}{(z-a)^m} + \frac{a_1}{(z-a)^{m-1}} + \cdots + \frac{a_{m-1}}{z-a} + \sum_{k=0}^{\infty} a_{m+k}(z-a)^k. \quad (1)$$

The function

$$p\left(\frac{1}{z-a}\right) = \sum_{k=1}^m \frac{a_{m-k}}{(z-a)^k}, \quad \text{where } p(z) = \sum_{k=1}^m a_{m-k}z^k,$$

is called the *principal part* of f at a .

Subtracting the principal part from f gives us a holomorphic function with a removable singularity at a . We can say that the singularity is “concentrated” in the principal part.

An isolated singularity, which is neither removable nor a pole, is called an *essential singularity*. In a small punctured disc around such a singularity the behaviour of f is very complicated as expressed by **Picard’s great theorem**:

For every $r > 0$ such that $K(a, r) \subseteq G$ the image $f(K'(a, r))$ is either \mathbb{C} or \mathbb{C} with the exception of one point.

We prove a weaker but still surprising result:

Theorem 6.11. (The Casorati-Weierstrass theorem). *Suppose that $f \in \mathcal{H}(G \setminus \{a\})$ has an essential singularity at $a \in G$. Then $f(K'(a, r))$ is dense in \mathbb{C}^9 for every $r > 0$ such that $K(a, r) \subseteq G$.*

Proof. Assuming the assertion not to be true, we can find $r > 0$ and a disc $K(c, \varepsilon) \subseteq \mathbb{C}$ such that

$$K(c, \varepsilon) \cap f(K'(a, r)) = \emptyset,$$

hence $|f(z) - c| \geq \varepsilon$ for $z \in K'(a, r)$. Therefore $g(z) = 1/(f(z) - c)$ is holomorphic in $K'(a, r)$ and bounded by $1/\varepsilon$. By Theorem 6.9 we get that g has a removable singularity at a . This makes it possible to assign a value $g(a)$ to g at a such that g becomes holomorphic in $K(a, r)$. By definition $g(z) \neq 0$ for $z \in K'(a, r)$.

If $g(a) \neq 0$ we have $\lim_{z \rightarrow a} f(z) = c + 1/g(a)$ showing that f has a removable singularity at a contrary to the hypothesis.

If $g(a) = 0$, then g has a zero at a , say of order $m \geq 1$. By Theorem 6.1 there exists $g_1 \in \mathcal{H}(K(a, r))$ such that

$$g(z) = (z-a)^m g_1(z), \quad g_1(a) \neq 0.$$

⁹A set $A \subseteq \mathbb{C}$ is called dense in \mathbb{C} if $\bar{A} = \mathbb{C}$, i.e., if $K(c, r) \cap A \neq \emptyset$ for all $c \in \mathbb{C}$, $r > 0$.

From the expression $f(z) = c + 1/g(z)$ we get

$$\lim_{z \rightarrow a} (z - a)^m f(z) = \lim_{z \rightarrow a} \left((z - a)^m c + \frac{1}{g_1(z)} \right) = \frac{1}{g_1(a)} \neq 0,$$

which shows that f has a pole of order m at a , but also this contradicts the hypothesis. \square

6.3. Rational functions.

By a *rational function* of a complex variable we understand an expression of the form $p(z)/q(z)$, where $p, q \in \mathbb{C}[z]$, $q \neq 0$. Like ordinary fractions we consider p_1/q_1 and p_2/q_2 as the same function if $p_1q_2 = q_1p_2$. If $z = a$ is a common zero of p and q , then $(z - a)$ raised to a suitable power is a common divisor of p and q , and it can be removed. In theoretical investigations we will therefore always assume that the two polynomials p, q have no common zeros. Under this assumption the function

$$f(z) = \frac{p(z)}{q(z)}$$

is holomorphic in $\mathbb{C} \setminus Z(q)$ and $Z(f) = Z(p)$. Let the zeros of q be a_1, \dots, a_k with the multiplicities m_1, \dots, m_k , hence

$$q(z) = c(z - a_1)^{m_1} \cdots (z - a_k)^{m_k}$$

for some constant $c \neq 0$, and it follows that a_1, \dots, a_k are isolated singularities of f and they are poles of multiplicities m_1, \dots, m_k . We have in fact

$$\begin{aligned} (z - a_1)^{m_1} f(z) &= \frac{p(z)}{c(z - a_2)^{m_2} \cdots (z - a_k)^{m_k}} \\ &\rightarrow \frac{p(a_1)}{c(a_1 - a_2)^{m_2} \cdots (a_1 - a_k)^{m_k}} \neq 0 \end{aligned}$$

for $z \rightarrow a_1$, and similarly for a_2, \dots, a_k .

The common notation in algebra of the set of rational functions is $\mathbb{C}(z)$. This set is a field under addition and multiplication because every element p/q from $\mathbb{C}(z) \setminus \{0\}$ has a reciprocal element q/p . It is the field of fractions of the integral domain¹⁰ $\mathbb{C}[z]$.

¹⁰A commutative ring R is called an integral domain if for all $a, b \in R$, $ab = 0$ implies $a = 0$ or $b = 0$.

Let us consider a rational function $f = p/q$, where $\deg(p) \geq \deg(q)$ and p, q have no common zeros. Dividing p by q we get by Theorem 4.24 $p = q_1q + r$ with $\deg(r) < \deg(q)$, hence

$$f(z) = q_1(z) + \frac{r(z)}{q(z)}.$$

We also see that r and q have no common zeros, because a common zero of these polynomials will also be a zero of p .

Theorem 6.12. (Partial fraction decomposition). *Assume that $r, q \in \mathbb{C}[z]$ have no common zeros and that $0 \leq \deg(r) < \deg(q)$. Let a_1, \dots, a_k be the zeros of q having the multiplicities m_1, \dots, m_k .*

There exist uniquely determined constants $c_{j,\ell} \in \mathbb{C}$ such that

$$\frac{r(z)}{q(z)} = \sum_{j=1}^k \sum_{\ell=1}^{m_j} \frac{c_{j,\ell}}{(z - a_j)^\ell}. \quad (1)$$

The formula (1) is called the partial fraction decomposition of the rational function. The right-hand side is the sum of the principal parts of the function.

Proof. Uniqueness of the decomposition. Assume that we have a decomposition (1). If $r > 0$ is so small that $K(a_j, r)$ does not contain any of the other zeros of q , then (1) can be written

$$\frac{r(z)}{q(z)} = \varphi(z) + \sum_{\ell=1}^{m_j} \frac{c_{j,\ell}}{(z - a_j)^\ell},$$

where $\varphi \in \mathcal{H}(K(a_j, r))$. Multiplying this expression with $(z - a_j)^{m_j}$, we get

$$\frac{r(z)}{q(z)}(z - a_j)^{m_j} = \varphi(z)(z - a_j)^{m_j} + \sum_{\ell=1}^{m_j} c_{j,\ell}(z - a_j)^{m_j - \ell}. \quad (2)$$

The function $(r(z)/q(z))(z - a_j)^{m_j}$ has a removable singularity at $z = a_j$, so in $K(a_j, r)$ it is the sum of its Taylor series with centre a_j :

$$\frac{r(z)}{q(z)}(z - a_j)^{m_j} = \sum_{n=0}^{\infty} c_n(z - a_j)^n. \quad (3)$$

The coefficients c_n in the Taylor series (3) are uniquely determined by the left-hand side of (3). In fact $n!c_n$ is the n 'th derivative of the left-hand side of (3) at a_j . Using that $\varphi \in \mathcal{H}(K(a_j, r))$, we see that $\varphi(z)(z - a_j)^{m_j}$ only

contributes to the Taylor series (3) with terms $c_n(z - a_j)^n$ for which $n \geq m_j$, while the terms with $n < m_j$ come from the finite sum in (2), hence

$$c_{m_j - \ell} = c_{j, \ell}, \quad \ell = 1, \dots, m_j,$$

showing that $c_{j, \ell}$ is uniquely determined.

The existence of the decomposition.

This is based on Liouville's theorem. To each pole a_j is associated a principal part

$$\sum_{\ell=1}^{m_j} \frac{c_{j, \ell}}{(z - a_j)^\ell},$$

and if we subtract all the principal parts we get the function

$$f(z) = \frac{r(z)}{q(z)} - \sum_{j=1}^k \sum_{\ell=1}^{m_j} \frac{c_{j, \ell}}{(z - a_j)^\ell},$$

which is holomorphic in \mathbb{C} . Each of the terms

$$\frac{c_{j, \ell}}{(z - a_j)^\ell}$$

converges to 0 for $|z| \rightarrow \infty$, and also the function $r(z)/q(z)$ converges to 0 for $|z| \rightarrow \infty$ because $\deg(q) > \deg(r)$. This shows that $f(z) \rightarrow 0$ for $|z| \rightarrow \infty$, but then f is necessarily bounded and hence constant by Liouville's theorem. A constant function approaching 0 for $|z| \rightarrow \infty$ must be identically zero. \square

The coefficients in the representation (1) can be found using the uniqueness proof above. For every j we can calculate the first m_j coefficients in the Taylor series for the function

$$\frac{r(z)}{q(z)}(z - a_j)^{m_j}.$$

It is however easier to reduce the problem to solving a system of linear equations. The method is illustrated in the following example.

Example 6.13. The following partial fraction decomposition holds:

$$\frac{z^3 + z^2 - 6z + 3}{z^4 - 2z^3 + z^2} = \frac{1}{z - 1} - \frac{1}{(z - 1)^2} + \frac{3}{z^2}.$$

Factorizing $z^4 - 2z^3 + z^2 = z^2(z - 1)^2$, we see that the fraction has poles of order 2 at $z = 0$ and $z = 1$. Our goal is to determine the coefficients a, b, c, d in the expression

$$\frac{z^3 + z^2 - 6z + 3}{z^2(z - 1)^2} = \frac{a}{z - 1} + \frac{b}{(z - 1)^2} + \frac{c}{z} + \frac{d}{z^2}.$$

We know by Theorem 6.12 that such a decomposition is possible.

Multiplying by $z^2(z-1)^2$, we get

$$\begin{aligned} z^3 + z^2 - 6z + 3 &= az^2(z-1) + bz^2 + cz(z-1)^2 + d(z-1)^2 \\ &= (a+c)z^3 + (-a+b-2c+d)z^2 + (c-2d)z + d, \end{aligned}$$

which is equivalent to the system of linear equations

$$a + c = 1, \quad -a + b - 2c + d = 1, \quad c - 2d = -6, \quad d = 3,$$

having the solution: $(a, b, c, d) = (1, -1, 0, 3)$.

Remark 6.14. The set $\mathbb{C}(z)$ is a vector space over the field \mathbb{C} . The preceding theory shows that the monomials $1, z, z^2, \dots$ together with the functions $1/(z-a)^k$, $a \in \mathbb{C}$, $k = 1, 2, \dots$ form a basis of the vector space.

6.4. Meromorphic functions.

A holomorphic function having only isolated singularities, which are either poles or removable singularities, is called a meromorphic function. It is natural to assign ∞ as the value of the function at the poles, and therefore we make the definition more precise in the following way:

Definition 6.15. A *meromorphic function* in a domain $G \subseteq \mathbb{C}$ is a mapping $h : G \rightarrow \mathbb{C} \cup \{\infty\}$ with the properties:

- (i) $P = \{z \in G \mid h(z) = \infty\}$ is discrete in G .
- (ii) The restriction $f = h|_{G \setminus P}$ is holomorphic in the open set $G \setminus P$.
- (iii) Every point $a \in P$ is a pole of f .

Notice that the set of poles P of f is countable and $G \setminus P$ is open by Theorem 5.6. The set of meromorphic¹¹ functions in G is denoted $\mathcal{M}(G)$.

A holomorphic function in G is meromorphic with $P = \emptyset$.

We will now show how a quotient f/g of two holomorphic functions $f, g \in \mathcal{H}(G)$, $g \not\equiv 0$, defines a meromorphic function h in G .

If $f \equiv 0$ we define $h \equiv 0$. Assume next that $f \not\equiv 0$.

Using that $Z(g)$ is discrete in G , we see that $h = f/g$ is holomorphic in $G \setminus Z(g)$, and all points in $Z(g)$ are isolated singularities of h . If $a \in Z(g)$ is a zero of order $q \geq 1$ of g , and a zero of order $p \geq 0$ of f , then we can write

$$f(z) = (z-a)^p f_1(z), \quad g(z) = (z-a)^q g_1(z),$$

¹¹meromorphic is derived from Greek: fractional form in contrast to holomorphic: whole form, “meros” meaning “part”, “holos” meaning “whole”.

where $f_1, g_1 \in \mathcal{H}(G)$ and $f_1(a), g_1(a)$ are both different from zero. We therefore see that

$$h(z) = (z - a)^{p-q} \frac{f_1(z)}{g_1(z)},$$

for $z \in K'(a, r)$, where r is chosen so small that g_1 is zero-free in $K(a, r)$. If $p \geq q$, then h has a removable singularity at a , and a is a zero of order $p - q$. If $p < q$, then h has a pole of order $m = q - p$ at a , and we define $h(a) = \infty$. This shows that h is a meromorphic function, and its set of poles consists of the points $a \in Z(g)$ for which $\text{ord}(g, a) > \text{ord}(f, a)$.

If $h : G \rightarrow \mathbb{C} \cup \{\infty\}$ is meromorphic and $a \in G$ is a pole of order m , then $f(z) = (z - a)^m h(z)$ is holomorphic in a suitable disc $K(a, r)$, hence $h(z) = f(z)/(z - a)^m$ in $K'(a, r)$. This shows that a meromorphic function h is *locally* a quotient of holomorphic functions, but this actually holds *globally*:

There exist $f, g \in \mathcal{H}(G)$ where $g \not\equiv 0$ such that $h = f/g$.

If P is the set of poles of h , there exists by §6.1 a holomorphic function $g \in \mathcal{H}(G)$ such that $Z(g) = P$, and g can be chosen such that the order of every zero $a \in Z(g)$ is equal to the order of the pole a of h . The function hg is holomorphic in $G \setminus P$, but having removable singularities at the points of P . There exists thus $f \in \mathcal{H}(G)$, such that $f = hg$ in $G \setminus P$, hence $h = f/g$.

We can add and multiply two meromorphic functions $h_1, h_2 : G \rightarrow \mathbb{C} \cup \{\infty\}$ by performing the addition and multiplication outside the union of the two sets of poles, giving a holomorphic function there. All the points in the union of the two sets of poles are isolated singularities which are either removable or poles, hence defining a meromorphic function. If h is meromorphic and not the zero function, then the reciprocal function $1/h$ is also meromorphic. Zeros of h of order n are poles of $1/h$ of order n , and poles of h of order m are zeros of $1/h$ of order m . It is easy to verify that the set $\mathcal{M}(G)$ of meromorphic functions in a domain G is a field. The representation $h = f/g$ of an arbitrary meromorphic function as a quotient of holomorphic functions shows that the field of meromorphic functions is isomorphic to the *field of fractions* of the integral domain $\mathcal{H}(G)$, cf. exc. 6.2.

A rational function is meromorphic in \mathbb{C} having only finitely many poles.

6.5. Laurent series.

The function $\exp(\frac{1}{z})$ is holomorphic in $\mathbb{C} \setminus \{0\}$ and $z = 0$ is an isolated

singularity. We know from real analysis that for all $n \geq 0$

$$\begin{aligned}\lim_{x \rightarrow 0^+} x^n \exp\left(\frac{1}{x}\right) &= \lim_{y \rightarrow \infty} \frac{\exp(y)}{y^n} = \infty, \\ \lim_{x \rightarrow 0^-} x^n \exp\left(\frac{1}{x}\right) &= \lim_{y \rightarrow \infty} (-1)^n \frac{\exp(-y)}{y^n} = 0,\end{aligned}$$

hence $z^n \exp(\frac{1}{z})$ has no limit for $z \rightarrow 0$, showing that $z = 0$ is neither a removable singularity nor a pole. Therefore $z = 0$ is an essential singularity.

Inserting the power series for \exp we get

$$\exp\left(\frac{1}{z}\right) = \sum_{n=0}^{\infty} \frac{1}{n! z^n}, \quad z \in \mathbb{C} \setminus \{0\}.$$

We shall study a type of infinite series generalizing power series and including the series above for $\exp(\frac{1}{z})$.

Definition 6.16. A *Laurent series*¹² is a doubly infinite series of the form

$$\sum_{n=-\infty}^{\infty} c_n z^n, \quad (1)$$

where $(c_n)_{n \in \mathbb{Z}}$ are given complex numbers and $z \in \mathbb{C} \setminus \{0\}$.

Concerning convergence of a Laurent series (1), we shall consider it as sum of two ordinary infinite series

$$\sum_{n=1}^{\infty} c_{-n} z^{-n} + \sum_{n=0}^{\infty} c_n z^n,$$

and we require each of them to be convergent. These series are power series in the variable $1/z$ and z respectively. Denoting their radii of convergence ρ_1, ρ_2 respectively, we see that the first series is absolutely convergent for $|1/z| < \rho_1$, the second for $|z| < \rho_2$. Only the case $1/\rho_1 < \rho_2$ is interesting, for then the series (1) is absolutely convergent in the *annulus*

$$G = \{z \in \mathbb{C} \mid 1/\rho_1 < |z| < \rho_2\},$$

which is the domain between the two concentric circles centered at 0 with radii $1/\rho_1, \rho_2$. (If $1/\rho_1 \geq \rho_2$ then $G = \emptyset$). In case $\rho_1 = \infty$ we have $G = K'(0, \rho_2)$ if $\rho_2 < \infty$, and $G = \mathbb{C} \setminus \{0\}$ if $\rho_2 = \infty$.

¹²Named after the French engineer P.A. Laurent (1813-1854).

The Laurent series converges locally uniformly in the annulus to the sum function, showing that it is holomorphic by Corollary 4.19. In fact, by Theorem 4.5 both power series converge uniformly on sets of the form $r_1 \leq |z| \leq r_2$, where $1/\rho_1 < r_1 \leq r_2 < \rho_2$, and since an arbitrary compact subset K of G is contained in $\{z \in \mathbb{C} \mid r_1 \leq |z| \leq r_2\}$ for suitable r_1, r_2 such that $1/\rho_1 < r_1 \leq r_2 < \rho_2$, the assertion follows. As suitable numbers we can simply use $r_1 = \inf\{|z| \mid z \in K\}$, $r_2 = \sup\{|z| \mid z \in K\}$.

Generalizing the above, we call the infinite series

$$\sum_{n=-\infty}^{\infty} c_n(z-a)^n$$

a Laurent series with centre $a \in \mathbb{C}$. It represents a holomorphic function in an *annulus with centre a* :

$$A(a; R_1, R_2) = \{z \in \mathbb{C} \mid R_1 < |z-a| < R_2\},$$

where $0 \leq R_1 < R_2 \leq \infty$ is the inner and outer radius respectively.

Laurent proved the converse of this, namely that every holomorphic function in an annulus is the sum function of a suitable Laurent series:

Theorem 6.17. *Assume that f is holomorphic in the annulus $A(a; R_1, R_2)$. Then f is the sum of a uniquely determined Laurent series*

$$f(z) = \sum_{n=-\infty}^{\infty} c_n(z-a)^n \text{ for } z \in A(a; R_1, R_2), \quad (2)$$

and the coefficients of the series are given by

$$c_n = \frac{1}{2\pi i} \int_{\partial K(a,r)} \frac{f(z)}{(z-a)^{n+1}} dz, \quad n \in \mathbb{Z}, \quad (3)$$

independent of $r \in]R_1, R_2[$.

Proof. We first show that if a Laurent series (2) is convergent with sum $f(z)$ for $z \in A(a; R_1, R_2)$, then the coefficients are given by (3), hence uniquely determined by f . In fact, using that the series (2) is uniformly convergent for $z \in \partial K(a, r)$, we get by Theorem 4.6 (ii) that

$$\begin{aligned} \frac{1}{2\pi i} \int_{\partial K(a,r)} \frac{f(z)}{(z-a)^{n+1}} dz &= \frac{1}{2\pi i} \int_{\partial K(a,r)} \left(\sum_{k=-\infty}^{\infty} c_k(z-a)^{k-n-1} \right) dz = \\ &= \sum_{k=-\infty}^{\infty} c_k \frac{1}{2\pi i} \int_{\partial K(a,r)} (z-a)^{k-n-1} dz = c_n \frac{1}{2\pi i} \int_{\partial K(a,r)} \frac{dz}{z-a} = c_n. \end{aligned}$$

(In principle we should split the series (2) in two series $\sum_0^\infty + \sum_{-\infty}^{-1}$ and then apply Theorem 4.6 (ii) to each of them, but we do not want to be too pedantic at this point).

In order to show the existence of a Laurent series as claimed, we define c_n by (3) and notice that the value is independent of $r \in]R_1, R_2[$ by §3.2. Fix $z_0 \in A(a; R_1, R_2)$ and choose r_1, r_2 such that $R_1 < r_1 < |z_0 - a| < r_2 < R_2$. We next choose $\varepsilon > 0$ so small that $\overline{K(z_0, \varepsilon)}$ is contained in the annulus $A(a; r_1, r_2)$.

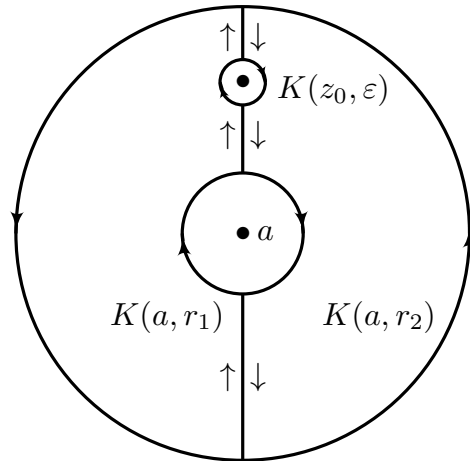

Figure 6.1

The function $F(z) = f(z)/(z - z_0)$ is holomorphic in $A(a; R_1, R_2) \setminus \{z_0\}$. We insert three segments situated on the line passing through the centres a and z_0 and connecting the three circles as shown on Figure 6.1. Using the orientations shown we obtain two closed paths C_1, C_2 over which the integral of F vanishes by Cauchy's integral theorem, hence

$$\int_{C_1} F(z)dz + \int_{C_2} F(z)dz = 0.$$

Using that the contributions from the three segments cancel, this equation can be written

$$\int_{\partial K(a, r_2)} F(z)dz = \int_{\partial K(a, r_1)} F(z)dz + \int_{\partial K(z_0, \varepsilon)} F(z)dz.$$

By Cauchy's integral formula we get

$$\begin{aligned} f(z_0) &= \frac{1}{2\pi i} \int_{\partial K(z_0, \varepsilon)} \frac{f(z)}{z - z_0} dz \\ &= \frac{1}{2\pi i} \int_{\partial K(a, r_2)} \frac{f(z)}{z - z_0} dz - \frac{1}{2\pi i} \int_{\partial K(a, r_1)} \frac{f(z)}{z - z_0} dz. \end{aligned} \quad (4)$$

We now transform the first integral into an infinite series in analogy with Theorem 4.8.

For $z \in \partial K(a, r_2)$ we have

$$\frac{1}{z - z_0} = \frac{1}{z - a} \frac{1}{1 - \frac{z_0 - a}{z - a}},$$

where $|(z_0 - a)/(z - a)| = \frac{|z_0 - a|}{r_2} < 1$. The last fraction is the sum of an infinite geometric series giving

$$\frac{1}{z - z_0} = \frac{1}{z - a} \sum_{n=0}^{\infty} \left(\frac{z_0 - a}{z - a} \right)^n,$$

hence

$$\frac{f(z)}{z - z_0} = \sum_{n=0}^{\infty} \frac{f(z)}{(z - a)^{n+1}} (z_0 - a)^n. \quad (5)$$

This series being uniformly convergent for $z \in \partial K(a, r_2)$, we are allowed to integrate term by term in (5), hence

$$\begin{aligned} \frac{1}{2\pi i} \int_{\partial K(a, r_2)} \frac{f(z)}{z - z_0} dz &= \sum_{n=0}^{\infty} \left(\frac{1}{2\pi i} \int_{\partial K(a, r_2)} \frac{f(z)}{(z - a)^{n+1}} dz \right) (z_0 - a)^n \\ &= \sum_{n=0}^{\infty} c_n (z_0 - a)^n. \end{aligned}$$

The series being convergent for arbitrary z_0 in the annulus, we see that its radius of convergence is $\geq R_2$.

For $z \in \partial K(a, r_1)$ we have similarly

$$\frac{1}{z - z_0} = \frac{1}{a - z_0} \frac{1}{1 - \frac{z - a}{z_0 - a}},$$

where $|(z - a)/(z_0 - a)| = \frac{r_1}{|z_0 - a|} < 1$, showing that the last fraction is the sum of an infinite geometric series, hence

$$\frac{1}{z - z_0} = \frac{1}{a - z_0} \sum_{n=0}^{\infty} \left(\frac{z - a}{z_0 - a} \right)^n$$

giving

$$\frac{f(z)}{z - z_0} = - \sum_{n=0}^{\infty} \frac{f(z)}{(z_0 - a)^{n+1}} (z - a)^n. \quad (6)$$

The series being uniformly convergent for $z \in \partial K(a, r_1)$, we can integrate term by term in (6) to get

$$\begin{aligned} \frac{1}{2\pi i} \int_{\partial K(a, r_1)} \frac{f(z)}{z - z_0} dz &= - \sum_{n=0}^{\infty} \left(\frac{1}{2\pi i} \int_{\partial K(a, r_1)} f(z)(z - a)^n dz \right) (z_0 - a)^{-n-1}, \\ &= - \sum_{n=0}^{\infty} c_{-n-1} (z_0 - a)^{-n-1}. \end{aligned}$$

The series being convergent for arbitrary z_0 in the annulus and being a power series in the variable $1/(z_0 - a)$, we see that the series converges for any z_0 such that $|z_0 - a| > R_1$, hence the power series

$$\sum_{n=1}^{\infty} c_{-n} w^n$$

has a radius of convergence $\geq 1/R_1$.

By (4) we now get

$$f(z_0) = \sum_{n=0}^{\infty} c_n (z_0 - a)^n + \sum_{n=1}^{\infty} \frac{c_{-n}}{(z_0 - a)^n} = \sum_{-\infty}^{\infty} c_n (z_0 - a)^n.$$

□

Remark 6.18. To a holomorphic function f in the annulus $A(a; R_1, R_2)$ is associated a holomorphic function f_i in $K(a, R_2)$ with the power series

$$f_i(z) = \sum_{n=0}^{\infty} c_n (z - a)^n$$

and a holomorphic function f_e in $\{z \in \mathbb{C} \mid |z - a| > R_1\}$ with the series expansion

$$f_e(z) = \sum_{n=1}^{\infty} \frac{c_{-n}}{(z - a)^n}.$$

For $z \in A(a; R_1, R_2)$ we have

$$f(z) = f_i(z) + f_e(z).^4$$

⁴The indices i and e are chosen for interior and exterior.

Remark 6.19. Let f be holomorphic in the annulus $A(a; R_1, R_2)$. For $r \in]R_1, R_2[$ we consider the function

$$g_r(\theta) = f(a + re^{i\theta}), \quad \theta \in \mathbb{R}$$

which is periodic with period 2π . By (2) we get

$$g_r(\theta) = \sum_{n=-\infty}^{\infty} c_n r^n e^{in\theta},$$

and this series converges uniformly for $\theta \in \mathbb{R}$, and is thus the Fourier series of g_r . Inserting the parameterization $a + re^{i\theta}$ of $\partial K(a, r)$, we can write formula (3) as

$$c_n r^n = \frac{1}{2\pi} \int_0^{2\pi} g_r(\theta) e^{-in\theta} d\theta,$$

which is the usual formula for the Fourier coefficients.

Let $G \subseteq \mathbb{C}$ be open and let $a \in G$. If $f \in \mathcal{H}(G \setminus \{a\})$, then f has an isolated singularity at a . Let $K(a, \rho)$ denote the largest open disc centered at a and contained in G . In particular, f is holomorphic in the annulus $K'(a, \rho) = A(a; 0, \rho)$, hence possesses a Laurent series

$$f(z) = \sum_{n=-\infty}^{\infty} c_n (z - a)^n, \quad z \in K'(a, \rho) \quad (7)$$

with

$$c_n = \frac{1}{2\pi i} \int_{\partial K(a, r)} \frac{f(z)}{(z - a)^{n+1}} dz, \quad n \in \mathbb{Z}, \quad (8)$$

where $r \in]0, \rho[$ is arbitrary.

By the Remark 6.18 we get a holomorphic function $f_i \in \mathcal{H}(K(a, \rho))$ given by

$$f_i(z) = \sum_{n=0}^{\infty} c_n (z - a)^n,$$

and a holomorphic function $f_e \in \mathcal{H}(\mathbb{C} \setminus \{a\})$ given by

$$f_e(z) = \sum_{n=1}^{\infty} \frac{c_{-n}}{(z - a)^n} \quad (9)$$

associated with the Laurent series, and we have

$$f(z) = f_i(z) + f_e(z) \quad \text{for } z \in K'(a, \rho). \quad (10)$$

Definition 6.20. Let $f \in \mathcal{H}(G \setminus \{a\})$. The function $f_e(z)$ given by (9) is called the *principal part* of f .

By (10) we see that $f(z) - f_e(z)$, which is holomorphic in $G \setminus \{a\}$, has a removable singularity at $z = a$ and $f_i(z)$ determines the holomorphic extension to the point a , the value at a being $f_i(a) = c_0$.

We shall now see how the type of the isolated singularity can be determined from the coefficients c_n of the Laurent series with negative index n .

Theorem 6.21. *The isolated singularity a of $f \in \mathcal{H}(G \setminus \{a\})$ with Laurent series (7) is*

- (i) *removable, if and only if $c_n = 0$ for $n < 0$,*
- (ii) *a pole, if and only if $c_n = 0$ for all $n < 0$ except finitely many. The order of the pole is the biggest $m > 0$ such that $c_{-m} \neq 0$,*
- (iii) *an essential singularity, if and only if $c_n \neq 0$ for infinitely many $n < 0$.*

Proof. (i) If $c_n = 0$ for $n < 0$, then $f_e = 0$ and f_i determines the holomorphic extension of f to a with the value $f(a) = c_0 = f_i(a)$. Assume next that a is a removable singularity. Then f can be considered as a holomorphic function in G , so when $n < 0$ we have $n + 1 \leq 0$ and therefore

$$\frac{f(z)}{(z-a)^{n+1}} \in \mathcal{H}(K(a, \rho)).$$

By Cauchy's integral theorem for the disc $K(a, \rho)$, we then get by (8) that $c_n = 0$ when $n < 0$.

(ii) If $c_{-m} \neq 0$ for an $m \geq 1$ and $c_{-n} = 0$ for $n > m$, then we can rewrite (7):

$$f(z) = \frac{c_{-m}}{(z-a)^m} + \frac{c_{-(m-1)}}{(z-a)^{m-1}} + \cdots + \frac{c_{-1}}{z-a} + \sum_{n=0}^{\infty} c_n (z-a)^n,$$

hence

$$(z-a)^m f(z) = \sum_{k=0}^{m-1} c_{-m+k} (z-a)^k + (z-a)^m \sum_{n=0}^{\infty} c_n (z-a)^n,$$

showing that

$$\lim_{z \rightarrow a} (z-a)^m f(z) = c_{-m} \neq 0,$$

i.e. a is a pole of order m .

If conversely $z = a$ is a pole of order $m \geq 1$, then the function $(z - a)^m f(z)$ has a removable singularity. The Laurent series of $(z - a)^m f(z)$ is obtained by multiplying (7) with $(z - a)^m$, hence

$$(z - a)^m f(z) = \sum_{n=-\infty}^{\infty} c_n (z - a)^{n+m} = \sum_{k=-\infty}^{\infty} c_{k-m} (z - a)^k.$$

By case (i) we infer that $c_{k-m} = 0$ for $k < 0$, hence $c_n = 0$ for $n < -m$.

(iii) The assertion is a consequence of (i) and (ii), because an essential singularity is an isolated singularity, which is neither removable nor a pole. Similarly, the condition for c_n in (iii) is precisely excluding the conditions for c_n in (i) and (ii). \square

Example 6.22. Let $f : \mathbb{C} \rightarrow \mathbb{C}$ be an *entire transcendental function*, i.e. an entire function which is not a polynomial. Equivalently, infinitely many coefficients c_n in the power series

$$f(z) = \sum_{n=0}^{\infty} c_n z^n, \quad z \in \mathbb{C}$$

are different from 0.

The function $f\left(\frac{1}{z}\right)$, $z \in \mathbb{C} \setminus \{0\}$ has an isolated singularity at $z = 0$ and we have the series expansion

$$f\left(\frac{1}{z}\right) = \sum_{n=0}^{\infty} \frac{c_n}{z^n}, \quad z \in \mathbb{C} \setminus \{0\}. \quad (12)$$

Because of the uniqueness of a Laurent series, we see that (12) is the Laurent series of $f\left(\frac{1}{z}\right)$. Having assumed that $c_n \neq 0$ for infinitely many n , we see that $z = 0$ is an essential singularity.

Example 6.23. The function

$$f(z) = \frac{1}{z-2} - \frac{1}{z-1} = \frac{1}{z^2 - 3z + 2}$$

is holomorphic in $\mathbb{C} \setminus \{1, 2\}$, and in particular it is holomorphic in $K(0, 1)$ and in the annuli $A(0; 1, 2)$ and $A(0; 2, \infty)$.

We shall determine the corresponding series expansions.

In $K(0, 1)$ $f(z)$ has a power series:

$$f(z) = \frac{1}{1-z} - \frac{1}{2} \frac{1}{1-\frac{z}{2}} = \sum_{n=0}^{\infty} \left(1 - \frac{1}{2^{n+1}}\right) z^n.$$

For $1 < |z| < 2$ we can make the following calculation

$$f(z) = -\frac{1}{z} \frac{1}{1 - \frac{1}{z}} - \frac{1}{2} \frac{1}{1 - \frac{z}{2}} = -\sum_{n=1}^{\infty} \frac{1}{z^n} - \sum_{n=0}^{\infty} \frac{1}{2^{n+1}} z^n,$$

which is the Laurent series in $A(0; 1, 2)$. For $2 < |z|$ we find

$$\begin{aligned} f(z) &= -\frac{1}{z} \frac{1}{1 - \frac{1}{z}} + \frac{1}{z} \frac{1}{1 - \frac{2}{z}} = -\sum_{n=1}^{\infty} \frac{1}{z^n} + \sum_{n=1}^{\infty} \frac{2^{n-1}}{z^n} \\ &= \sum_{n=2}^{\infty} (2^{n-1} - 1) \frac{1}{z^n}. \end{aligned}$$

We get three different series expansions in three disjoint domains. It is important not to mix up these series, but there are four more series of interest, two Laurent series with centre 1 and two Laurent series with centre 2.

The function has a simple pole at $z = 1$. It therefore has a Laurent series with centre 1 in the annulus $A(1; 0, 1)$, i.e. for z verifying $0 < |z - 1| < 1$:

$$f(z) = -\frac{1}{1 - (z - 1)} - \frac{1}{z - 1} = -\frac{1}{z - 1} - \sum_{n=0}^{\infty} (z - 1)^n.$$

It has another Laurent series in the annulus $A(1; 1, \infty)$, i.e. valid for $|z - 1| > 1$:

$$f(z) = \frac{1}{(z - 1)(1 - \frac{1}{z-1})} - \frac{1}{z - 1} = \sum_{n=2}^{\infty} \frac{1}{(z - 1)^n}.$$

The function has also a simple pole at $z = 2$. It is holomorphic in the annulus $A(2; 0, 1)$ and has therefore a Laurent series with centre $z = 2$ valid for $0 < |z - 2| < 1$:

$$f(z) = \frac{1}{z - 2} - \frac{1}{1 + (z - 2)} = \frac{1}{z - 2} + \sum_{n=0}^{\infty} (-1)^{n+1} (z - 2)^n.$$

In the annulus $A(2; 1, \infty)$, i.e. for $|z - 2| > 1$ we have

$$f(z) = \frac{1}{z - 2} - \frac{1}{(z - 2)(1 + \frac{1}{z-2})} = \sum_{n=2}^{\infty} \frac{(-1)^n}{(z - 2)^n}.$$

Remark about the radius of convergence. Let $f \in \mathcal{H}(\mathbb{C} \setminus P)$, where $P \subseteq \mathbb{C}$ is discrete in \mathbb{C} , and assume that none of the singularities $a \in P$ are removable. For every $z_0 \in \mathbb{C} \setminus P$ we can represent f by a power series

$$f(z) = \sum_{n=0}^{\infty} a_n (z - z_0)^n \quad (13)$$

in the largest open disc $K(z_0, \rho) \subseteq \mathbb{C} \setminus P$. It is clear that

$$\rho = \inf\{|z_0 - a| \mid a \in P\}.$$

Notice that the infimum is actually a minimum, hence $\rho = |z_0 - a|$ for some point $a \in P$, cf. Lemma A.1 with $K = \{z_0\}$, $F = P$.

Theorem 6.24. *With the notation above the radius of convergence of (13) is equal to ρ .*

Proof. By Theorem 4.8 we know that the radius of convergence R satisfies $R \geq \rho$. Assuming $R > \rho$, we see that (13) defines a holomorphic extension of f to $K(z_0, R)$. However, a point $a \in P$ satisfying $|a - z_0| = \rho$ belongs to $K(z_0, R)$, but then a has to be a removable singularity, contradicting the assumption. \square

Exercises for §6

6.1. Let G be a domain in \mathbb{C} and assume that $f \in \mathcal{H}(G)$ has only finitely many zeros in G . Prove that there exists a polynomial $p(z)$ and a zero-free function $\varphi \in \mathcal{H}(G)$ such that $f(z) = p(z)\varphi(z)$ for $z \in G$.

6.2. Let $G \subseteq \mathbb{C}$ be open. Prove that the ring $\mathcal{H}(G)$ is an integral domain if and only if G is path connected.

Recall that a commutative ring R is an integral domain if

$$\forall a, b \in R : ab = 0 \Rightarrow a = 0 \vee b = 0.$$

6.3. *The reflection principle.* The mapping $z \rightarrow \bar{z}$ is a reflection in the real axis.

1° Let $G \subseteq \mathbb{C}$ be open and $f \in \mathcal{H}(G)$. The reflected set and the reflected function are defined by

$$G^* = \{ z \in \mathbb{C} \mid \bar{z} \in G \}$$

$$f^* : G^* \rightarrow \mathbb{C}, f^*(z) = \overline{f(\bar{z})}, z \in G^*.$$

Prove that $f^* \in \mathcal{H}(G^*)$ and that $(f^*)' = (f')^*$.

2° Let $G \subseteq \mathbb{C}$ be a domain which is *reflection invariant*, i.e. $G = G^*$. Prove that $G \cap \mathbb{R} \neq \emptyset$.

Prove that $f \in \mathcal{H}(G)$ is real-valued on $G \cap \mathbb{R}$ if and only if f is *reflection invariant*, i.e. $f = f^*$ or

$$f(\bar{z}) = \overline{f(z)} \text{ for all } z \in G.$$

Hint. Make use of the identity theorem.

3° Prove that an entire function $f(z) = \sum_0^\infty a_n z^n$ is reflection invariant if and only if $a_n \in \mathbb{R}$ for $n = 0, 1, \dots$

6.4. Determine $a \in \mathbb{C}$ such that $\sin z - z(1 + az^2) \cos z$ has a zero of fifth order at $z = 0$.

6.5. Assume that $h : \mathbb{C} \rightarrow \mathbb{C} \cup \{\infty\}$ is meromorphic with finitely many poles z_1, \dots, z_n and assume that there exist $k > 0$, $N \in \mathbb{N}$ and $R > 0$ such that $|h(z)| \leq k|z|^N$ for $|z| > R$. Prove that h is a rational function.

Hint. Make use of exc. 4.9.

6.6. Find $a_k \in \mathbb{C}, k = 1, \dots, 4$ such that

$$\frac{4z^3}{(z^2 + 1)^2} = \frac{a_1}{z + i} + \frac{a_2}{(z + i)^2} + \frac{a_3}{z - i} + \frac{a_4}{(z - i)^2}.$$

6.7. Find the partial fraction decomposition of the rational function

$$f(z) = \frac{2z - (2 + i)}{z^2 - (2 + i)z + 2i}$$

and find next its Laurent series in the annulus $A(0; 1, 2)$.

6.8. Let f be holomorphic in the annulus $A(a; R_1, R_2)$ and let f_i, f_e be the holomorphic functions from Remark 6.18. Prove that

$$f_e(z) \rightarrow 0 \text{ for } |z - a| \rightarrow \infty.$$

Assume next that there exists a holomorphic function ϕ_i in $K(a, R_2)$ and a holomorphic function ϕ_e in the domain $\{z \in \mathbb{C} \mid |z - a| > R_1\}$ such that

$$\phi_e(z) \rightarrow 0 \text{ for } |z - a| \rightarrow \infty,$$

and

$$f(z) = \phi_i(z) + \phi_e(z) \text{ for } z \in A(a; R_1, R_2).$$

Prove that $f_i(z) = \phi_i(z)$ for $z \in K(a, R_2)$ and $f_e(z) = \phi_e(z)$ for $|z - a| > R_1$.

Hint. Make use of Liouville's Theorem for the function

$$g(z) = \begin{cases} f_i(z) - \phi_i(z), & |z - a| < R_2 \\ \phi_e(z) - f_e(z), & |z - a| > R_1. \end{cases}$$

6.9. Let $f \in \mathcal{H}(G)$, where G is a simply connected domain. Let γ be a closed path in G . Prove the following extension of *Cauchy's integral formula*

$$\omega(\gamma, z_0)f(z_0) = \frac{1}{2\pi i} \int_{\gamma} \frac{f(z)}{z - z_0} dz, \quad z_0 \in G \setminus \gamma^*.$$

Hint. Make use of the fact that $z \mapsto (f(z) - f(z_0))/(z - z_0)$ has a removable singularity at z_0 .

6.10. Let $a \in \mathbb{C}$. Determine the Laurent series in the annulus (punctured plane) $\mathbb{C} \setminus \{a\}$ of the function

$$f(z) = \frac{\exp(z)}{(z - a)^3}.$$

6.11. For $z \in \mathbb{C}$ we consider the function

$$f(\omega) = \exp\left(\frac{z}{2}\left(\omega - \frac{1}{\omega}\right)\right), \quad \omega \in \mathbb{C} \setminus \{0\},$$

which is holomorphic in $\mathbb{C} \setminus \{0\}$. Prove that the Laurent series can be written

$$\exp\left(\frac{z}{2}\left(\omega - \frac{1}{\omega}\right)\right) = \sum_{n=-\infty}^{\infty} J_n(z)\omega^n, \quad \omega \in \mathbb{C} \setminus \{0\},$$

where

$$J_n(z) = \frac{1}{2\pi} \int_{-\pi}^{\pi} e^{i(z \sin t - nt)} dt = \frac{1}{\pi} \int_0^{\pi} \cos(z \sin t - nt) dt, \quad n \in \mathbb{Z}.$$

The function $J_n : \mathbb{C} \rightarrow \mathbb{C}$ is called the *Bessel function* of order n .

Prove that

$$z(J_{n-1}(z) + J_{n+1}(z)) = 2nJ_n(z).$$

6.12. Explain why $f(z) = z/(e^z - 1)$ has a removable singularity at $z = 0$ and is holomorphic in the disc $K(0, 2\pi)$. The power series of f with centre $z = 0$ is denoted

$$\frac{z}{e^z - 1} = \sum_{n=0}^{\infty} \frac{B_n}{n!} z^n, \quad \text{hence } B_n = f^{(n)}(0).$$

Prove that the radius of convergence is 2π and that the *Bernoulli numbers* B_n are determined by the equations

$$B_0 = 1, \quad \sum_{k=0}^n B_k \binom{n+1}{k} = 0, \quad n = 1, 2, \dots$$

Prove that each B_n is a rational number and verify the values

$$B_1 = -\frac{1}{2}, \quad B_2 = \frac{1}{6}, \quad B_3 = 0, \quad B_4 = -\frac{1}{30}.$$

Prove that the function

$$g(z) = \frac{z}{e^z - 1} - 1 + \frac{z}{2}$$

is even (i.e. $g(-z) = g(z)$) and conclude that $B_{2n+1} = 0$ for $n \geq 1$.

6.13. Prove that the Laurent series of $\cot z$, $0 < |z| < \pi$, is given by

$$\cot z = \frac{1}{z} + \sum_{k=1}^{\infty} (-1)^k \frac{B_{2k}}{(2k)!} 2^{2k} z^{2k-1},$$

where B_n are the Bernoulli numbers from exc. 6.12.

Hint. Make use of Euler's formulas from Theorem 1.16.

6.14. Let $z_1, \dots, z_n \in K(0, r)$ be mutually different, let $\alpha_1, \dots, \alpha_n \in \mathbb{C}$ and consider the rational function

$$f(z) = \sum_{j=1}^n \frac{\alpha_j}{z - z_j},$$

which is holomorphic in $\mathbb{C} \setminus \{z_1, \dots, z_n\}$.

Prove that f has a primitive in the domain $\{z \in \mathbb{C} \mid |z| > r\}$ if and only if $\sum_{j=1}^n \alpha_j = 0$.

Hint. Make use of Theorem 2.13 and exc. 5.13.

6.15. Prove that the function $z/(1 - z - z^2)$ has simple poles at $z = (-1 \pm \sqrt{5})/2$ and determine the radius of convergence of the power series:

$$\frac{z}{1 - z - z^2} = \sum_0^{\infty} F_n z^n.$$

Prove that $F_0 = 0$, $F_1 = 1$, $F_n = F_{n-1} + F_{n-2}$, $n \geq 2$. (This is the sequence of *Fibonacci numbers*: 0, 1, 1, 2, 3, 5, 8, ...).

Find the partial fraction decomposition of the rational function and use it to prove Binet's formula

$$F_n = \frac{1}{\sqrt{5}} \left[\left(\frac{1 + \sqrt{5}}{2} \right)^n - \left(\frac{1 - \sqrt{5}}{2} \right)^n \right].$$

6.16. Prove that Picard's Theorem 4.21 can be deduced from Picard's great theorem on p. 6.7.

Hint. Let f be an entire function. Look at $f(1/z)$ in $\mathbb{C} \setminus \{0\}$.

§7. The calculus of residues

In this section we introduce residues and prove Cauchy's residue theorem, which can be seen as the culmination of the complex analysis developed by Cauchy. In addition to theoretical applications like the theorem of Rouché, the residue theorem makes it possible to calculate definite integrals and to evaluate sums of infinite series.

The fact that an integral of the type

$$\int_{-\infty}^{\infty} \frac{x^2}{(x^2 + 1)^2} dx$$

can be evaluated by calculating a residue at $z = i$ can seem like magic.

7.1. The residue theorem.

Let $f \in \mathcal{H}(G \setminus \{a\})$ have an isolated singularity at $z = a \in G$ and let

$$f(z) = \sum_{n=-\infty}^{\infty} c_n (z - a)^n \quad (1)$$

be the Laurent series with centre a .

The coefficient c_{-1} is particularly important and is called the *residue* of f at the point a . It is denoted $\text{Res}(f, a)$, hence by §6.5 (8)

$$\text{Res}(f, a) = c_{-1} = \frac{1}{2\pi i} \int_{\partial K(a, r)} f(z) dz \quad (2)$$

for $0 < r < \rho$, where $K(a, \rho)$ is the largest open disc in G centered at a .

Residues were introduced by Cauchy. The residue is what remains, apart from the factor $2\pi i$, when the function f is integrated along a path surrounding the singularity. By §3.2 the circle $\partial K(a, r)$ can be replaced by other simple closed paths moving counterclockwise around the singularity.

We shall now formulate and prove Cauchy's residue theorem. Because of its many applications, it is one of the most important theorems in complex analysis. We note that it includes the integral theorem and the integral formula of Cauchy.

Theorem 7.1. (Cauchy's residue theorem). *Let G be a simply connected domain and let $P = \{a_1, \dots, a_n\} \subseteq G$. Let γ be a simple closed path in G surrounding a_1, \dots, a_n with positive orientation.¹³ For $f \in \mathcal{H}(G \setminus P)$ we have*

$$\int_{\gamma} f(z) dz = 2\pi i \sum_{j=1}^n \text{Res}(f, a_j).$$

¹³We use an intuitive geometric formulation.

Proof. Let p_j denote the principal part of f at the point a_j , $j = 1, \dots, n$, cf. Definition 6.20. Then $\varphi = f - (p_1 + \dots + p_n)$ has a removable singularity at each of the points a_1, \dots, a_n , and therefore it has a holomorphic extension to G . By Cauchy's integral theorem we know that $\int_\gamma \varphi = 0$, hence

$$\int_\gamma f = \sum_{j=1}^n \int_\gamma p_j.$$

The principal part p_j is holomorphic in $\mathbb{C} \setminus \{a_j\}$. For $r > 0$ sufficiently small the path γ also surrounds $\overline{K(a_j, r)}$ and using the idea of §3.2 it can be proved that

$$\int_\gamma p_j = \int_{\partial K(a_j, r)} p_j.$$

(We skip the details. In concrete applications of the theorem these matters are usually obvious). Assume that the principal part p_j is given by the expansion

$$p_j(z) = \sum_{n=1}^{\infty} \frac{c_{j,n}}{(z - a_j)^n}.$$

The series being uniformly convergent on $\partial K(a_j, r)$, we see by Theorem 4.6 (ii) that

$$\int_{\partial K(a_j, r)} p_j = \sum_{n=1}^{\infty} \int_{\partial K(a_j, r)} \frac{c_{j,n}}{(z - a_j)^n} dz = 2\pi i \operatorname{Res}(f, a_j).$$

In fact, only the term for $n = 1$ yields a contribution, namely $2\pi i \operatorname{Res}(f, a_j)$, because the integrands in the terms for higher values of n have a primitive. \square

We shall now give some simple devices for calculating residues at poles of a meromorphic function h .

1° Assume that h has a simple pole at a .

Then

$$\operatorname{Res}(h, a) = \lim_{z \rightarrow a} (z - a)h(z).$$

In fact, in a sufficiently small disc $K(a, r)$ we have by the Laurent expansion

$$h(z) = \frac{\operatorname{Res}(h, a)}{z - a} + \varphi(z),$$

and φ is holomorphic.

2° Assume that $h = f/g$, where f, g are holomorphic such that $f(a) \neq 0$, $g(a) = 0$, $g'(a) \neq 0$, hence h has a simple pole at a .

Then

$$\operatorname{Res}(h, a) = f(a)/g'(a).$$

In fact, by 1° we get

$$\operatorname{Res}(h, a) = \lim_{z \rightarrow a} f(z) \frac{z-a}{g(z)} = \lim_{z \rightarrow a} f(z) \left(\frac{g(z) - g(a)}{z-a} \right)^{-1} = \frac{f(a)}{g'(a)}.$$

3° Assume that h has a pole of order $m \geq 1$ at a .

Defining $\varphi(z) = (z-a)^m h(z)$, then φ has a removable singularity at a and we get

$$\operatorname{Res}(h, a) = \frac{\varphi^{(m-1)}(a)}{(m-1)!}.$$

In fact, by the Laurent expansion of h similar to (1) we get

$$\varphi(z) = c_{-m} + c_{-m+1}(z-a) + \cdots + c_{-1}(z-a)^{m-1} + c_0(z-a)^m + \cdots \quad (3)$$

and we know $c_{-1} = \operatorname{Res}(h, a)$. However, the coefficient c_{-1} to $(z-a)^{m-1}$ in (3) can also be found as the right-hand side of the formula we want to prove.

Example 7.2. (i) The residue of the rational function $z \mapsto 1/(1+z^2)$ at $z = \pm i$ is $\mp \frac{i}{2}$. This follows by 2°, but can also be inferred from the decomposition

$$\frac{1}{1+z^2} = \frac{i}{2(z+i)} - \frac{i}{2(z-i)}.$$

(ii) The meromorphic function $z \mapsto 1/\sin z$ has a simple pole at $z = n\pi$, $n \in \mathbb{Z}$. The residue at $z = n\pi$ is $1/\cos(n\pi) = (-1)^n$ by 2°.

(iii) The function

$$h(z) = \frac{z \sin z}{1 - \cos z}$$

is meromorphic in \mathbb{C} . The zeros of the denominator are $2p\pi$, $p \in \mathbb{Z}$, and they all have multiplicity 2. The numerator has a double zero at $z = 0$ and simple zeros at $z = p\pi$, $p \in \mathbb{Z} \setminus \{0\}$. We conclude that $z = 0$ is a removable singularity and $z = 2p\pi$, $p \in \mathbb{Z} \setminus \{0\}$ are simple poles of h .

To find the value of h at the removable singularity $z = 0$, we develop the numerator and the denominator in power series using the known power series for \sin and \cos :

$$h(z) = \frac{z \left(z - \frac{z^3}{3!} + \cdots \right)}{\frac{z^2}{2!} - \frac{z^4}{4!} + \cdots} = \frac{1 - \frac{z^2}{3!} + \cdots}{\frac{1}{2!} - \frac{z^2}{4!} + \cdots} \rightarrow 2 \quad \text{for } z \rightarrow 0.$$

Alternatively we can make use of L'Hospital's rule (Theorem 6.7), yielding

$$\lim_{z \rightarrow 0} h(z) = \frac{f^{(2)}(0)}{g^{(2)}(0)} = 2,$$

where $f(z) = z \sin z$, $g(z) = 1 - \cos z$.

To calculate the residues at $2p\pi$, $p \neq 0$ we put $w = z - 2p\pi$, and by the periodicity of \sin and \cos we get

$$\begin{aligned} (z - 2p\pi)h(z) &= \frac{w(w + 2p\pi) \sin(w + 2p\pi)}{1 - \cos(w + 2p\pi)} \\ &= \frac{(w + 2p\pi)w \sin w}{1 - \cos w} = (w + 2p\pi)h(w). \end{aligned}$$

Moreover, since $z \rightarrow 2p\pi \Leftrightarrow w \rightarrow 0$ we find

$$\operatorname{Res}(h, 2p\pi) = \lim_{z \rightarrow 2p\pi} (z - 2p\pi)h(z) = \lim_{w \rightarrow 0} (w + 2p\pi)h(w) = 4p\pi.$$

Here we also used $\lim_{w \rightarrow 0} h(w) = 2$ as shown above.

(iv) $h(z) = z^2(z^2 + 1)^{-2}$ is a rational function with poles of order 2 at the points $z = \pm i$. We find the residues using 3°. Defining

$$\varphi(z) = (z - i)^2 h(z) = \frac{z^2}{(z + i)^2},$$

we get

$$\varphi'(z) = \frac{2iz}{(z + i)^3},$$

hence $\operatorname{Res}(h, i) = \varphi'(i) = -\frac{i}{4}$. Analogously we get $\operatorname{Res}(h, -i) = \frac{i}{4}$.

7.2. The principle of argument.

The residue theorem can be used to calculate the number of zeros and poles of a meromorphic function.

Theorem 7.3. *Let $h : G \rightarrow \mathbb{C} \cup \{\infty\}$ be meromorphic in a simply connected domain G and let γ be a positively oriented simple closed path in G not passing through any zeros or poles of h . Then*

$$\frac{1}{2\pi i} \int_{\gamma} \frac{h'(z)}{h(z)} dz = Z - P,$$

where Z is the number of zeros and P the number of poles of h in the sub-domain of G enclosed by γ . In the calculation of Z and P a zero or a pole of order m is counted as m .

Proof. Let D be the set of zeros or poles of h . Then h'/h is holomorphic in $G \setminus D$. We will see that h'/h is meromorphic having D as the set of poles. Letting a denote a zero of h of order n , we have by Theorem 6.1 for $z \in K(a, r)$, where r is sufficiently small,

$$h(z) = (z - a)^n g(z), \quad g \in \mathcal{H}(K(a, r)), \quad g(a) \neq 0,$$

hence

$$h'(z) = n(z - a)^{n-1} g(z) + (z - a)^n g'(z),$$

leading to

$$\frac{h'(z)}{h(z)} = \frac{n}{z - a} + \frac{g'(z)}{g(z)},$$

which proves that h'/h has a simple pole at a with the residue n .

Letting b denote a pole of h of order m , we have (see page 6.6) for $z \in K'(b, r)$, where r is sufficiently small,

$$h(z) = (z - b)^{-m} g(z), \quad g \in \mathcal{H}(K(b, r)), \quad g(b) \neq 0,$$

hence

$$h'(z) = -m(z - b)^{-(m+1)} g(z) + (z - b)^{-m} g'(z),$$

leading to

$$\frac{h'(z)}{h(z)} = \frac{-m}{z - b} + \frac{g'(z)}{g(z)},$$

which proves that h'/h has a simple pole at b with the residue $-m$.

Let $\{a_1, \dots, a_n\}$ be those points from D which are enclosed by γ . We now use an intuitive fact (which we do not prove) that there exists a simply connected sub-domain $G_1 \subseteq G$ such that $D \cap G_1 = \{a_1, \dots, a_n\}$ and γ is in G_1 . Applying the residue theorem for $h'/h \in \mathcal{H}(G_1 \setminus \{a_1, \dots, a_n\})$, we get

$$\frac{1}{2\pi i} \int_{\gamma} \frac{h'(z)}{h(z)} dz = \sum_{j=1}^n \text{Res}(h'/h, a_j) = Z - P,$$

since $\text{Res}(h'/h, a_j) = \pm m$ with $+$ if a_j is a zero and $-$ if a_j is a pole of order m .

□

Remark 7.4. (The principle of argument). Let $\Gamma = h \circ \gamma$ be the closed path obtained by taking the values of h along γ . Notice that Γ stays in $\mathbb{C} \setminus \{0\}$, because h has no zeros and poles on γ^* . Denoting the interval of definition of γ by $[a, b]$, then the integral from Theorem 7.3 is equal to

$$\frac{1}{2\pi i} \int_a^b \frac{h'(\gamma(t))\gamma'(t)}{h(\gamma(t))} dt = \frac{1}{2\pi i} \int_{\Gamma} \frac{dz}{z} = \omega(\Gamma, 0).$$

We can thus express the result of Theorem 7.3 as

$$\omega(\Gamma, 0) = Z - P$$

or

$$\operatorname{argvar}(\Gamma) = 2\pi(Z - P).$$

This is the reason for calling Theorem 7.3 the **principle of argument**: *A continuous branch of $\arg(h(\gamma(t)))$ changes its value by $2\pi(Z - P)$ by following the path once in positive orientation.*

As an example let us consider $h(z) = \sin z$ for $z \in \mathbb{C}$. If we follow $\sin z$ along the unit circle counterclockwise, then a continuous branch of $\arg(\sin(e^{it}))$ will increase by 2π because $\sin z$ has a simple zero $z = 0$ inside the unit circle. Furthermore, if we follow $\sin^2 z$ around the circle $|z| = 4$, the argument will increase by 12π because there are 3 double zeros in the disc $K(0, 4)$.

Theorem 7.5. (Rouché's Theorem)¹⁴. *Let $f, g \in \mathcal{H}(G)$ in a simply connected domain G . Let γ be a simple closed path in G such that*

$$|f(z) - g(z)| < |f(z)| + |g(z)| \quad \text{for } z \in \gamma^*. \quad (1)$$

Then f and g have the same number of zeros counted with multiplicity in the bounded domain enclosed by γ .

Proof. By (1) we get that $f(z) \neq 0$ and $g(z) \neq 0$ for $z \in \gamma^*$. The function $F(z) = g(z)/f(z)$ is meromorphic in G and

$$\frac{F'}{F} = \frac{g'}{g} - \frac{f'}{f}.$$

The set

$$\tilde{G} = \{z \in G \mid f(z) \neq 0\}$$

is open and $\gamma^* \subseteq \tilde{G} \subseteq G$, $F \in \mathcal{H}(\tilde{G})$. The assumption (1) about f, g can be expressed

$$|1 - F(z)| < 1 + |F(z)| \quad \text{for } z \in \gamma^*,$$

¹⁴Eugène Rouché, French mathematician, 1832-1910.

and F being continuous in \tilde{G} , we get that

$$\Omega := \{z \in \tilde{G} \mid |1 - F(z)| < 1 + |F(z)|\}$$

is open and $\gamma^* \subseteq \Omega$. Note that $\{w \in \mathbb{C} \mid |1 - w| < 1 + |w|\} = \mathbb{C}_\pi$, so $F(\Omega) \subseteq \mathbb{C}_\pi$.

Since Log is holomorphic in \mathbb{C}_π , we see that $\text{Log } F$ is holomorphic in Ω and is a primitive of F'/F in Ω , hence

$$0 = \frac{1}{2\pi i} \int_\gamma \frac{F'}{F} = \frac{1}{2\pi i} \int_\gamma \frac{g'}{g} - \frac{1}{2\pi i} \int_\gamma \frac{f'}{f}.$$

If γ is positively oriented, then the assertion follows by Theorem 7.3. \square

As an application of Rouché's theorem we will give a proof of the fundamental theorem of algebra, cf. Theorem 4.23.

Let $g(z) = z^n + a_{n-1}z^{n-1} + \cdots + a_1z + a_0$ be a normalized polynomial of degree $n \geq 1$ and let $f(z) = z^n$. On the circle $\gamma(t) = Re^{it}$, $t \in [0, 2\pi]$ we have $|f(z)| = R^n$ and

$$|f(z) - g(z)| \leq |a_{n-1}|R^{n-1} + \cdots + |a_1|R + |a_0|.$$

The right-hand side of the inequality is $< R^n$ provided R is sufficiently big, i.e. provided $R \geq R_0$ for suitable R_0 . This shows that f and g have the same number of zeros in the disc $K(0, R_0)$. Clearly, $f(z) = z^n$ has $z = 0$ as a zero of multiplicity n , and therefore g has n zeros in $K(0, R_0)$ counted with multiplicity.

As another application of Rouché's theorem we shall prove the **open mapping theorem**:

Theorem 7.6. *Let f be a non-constant holomorphic function in a domain $G \subseteq \mathbb{C}$. Then $f(G)$ is a domain in \mathbb{C} .*

In particular f is an open mapping, i.e. $f(\Omega)$ is open in \mathbb{C} for every open subset $\Omega \subseteq G$.

Proof. The second part follows from the first part because every open set $\Omega \subseteq G$ is a union of discs

$$\Omega = \bigcup_{i \in I} K(a_i, r_i),$$

and therefore

$$f(\Omega) = \bigcup_{i \in I} f(K(a_i, r_i))$$

is the union of the domains $f(K(a_i, r_i))$, hence open.

We shall now prove that $f(G)$ is open, hence a domain, the latter because of Theorem A.6, which implies that $f(G)$ is path connected since G is so.

Fix $w_0 = f(z_0)$ for $z_0 \in G$. We shall find $\rho > 0$ such that $K(w_0, \rho) \subseteq f(G)$. To do this we consider the function $\varphi(z) = f(z) - w_0$, which has a zero at $z = z_0$, and let $k \geq 1$ be the order of this zero. Since zeros of holomorphic functions are isolated, there exists $r > 0$ such that $\overline{K(z_0, r)} \subseteq G$ and $f(z) - w_0 \neq 0$ for $z \in \overline{K(z_0, r)} \setminus \{z_0\}$.

By Theorem A.3 we thus get

$$\rho := \inf\{|f(z) - w_0| \mid z \in \partial K(z_0, r)\} > 0.$$

By Lemma 3.6 there exists $R > 0$ such that $\overline{K(z_0, r)} \subset K(z_0, R) \subset G$.

Fixing $w \in K(w_0, \rho)$, we will apply Rouché's Theorem to the two functions $\varphi(z) = f(z) - w_0$, $\psi(z) = f(z) - w$, which are both holomorphic in G , hence in $K(z_0, R)$.

For $|z - z_0| = r$ we have

$$|\varphi(z) - \psi(z)| = |w - w_0| < \rho \leq |\varphi(z)|,$$

and therefore ψ has the same number of zeros in $K(z_0, r)$ as φ has, namely k zeros, i.e. there exist $z \in K(z_0, r)$ such that $\psi(z) = f(z) - w = 0$.

Summing up: To every $w \in K(w_0, \rho)$ there exists $z \in K(z_0, r)$ such that $f(z) = w$, hence $K(w_0, \rho) \subseteq f(K(z_0, r)) \subseteq f(G)$. \square

7.3. Calculation of definite integrals.

The residue theorem can be applied to calculate definite integrals. An idea to calculate $\int_{-\infty}^{\infty} f(x)dx$ is roughly speaking this: Choose a closed path γ in \mathbb{C} containing the segment $[-R, R]$, e.g. a half-circle over the segment or a rectangle having the segment as one side. Consider a meromorphic function F in \mathbb{C} agreeing with f on the real axis (often it suffices just to write $f(z)$ instead of $f(x)$). The integral of f from $-R$ to R plus the integral along the remaining part of the path is equal to $2\pi i$ multiplied by the sum of the residues at the poles inside the path. Letting $R \rightarrow \infty$, it often happens that the contribution from "the remaining part of the path" tends to 0, and in the limit we find the integral in question.

Example 7.7. Let us calculate

$$\int_{-\infty}^{\infty} \frac{x^2}{(x^2 + 1)^2} dx.$$

We consider the half-circle $\varphi(t) = Re^{it}$, $t \in [0, \pi]$ in the upper half-plane, and together with the interval $[-R, R]$ we get a simple closed path oriented as on Figure 7.1.

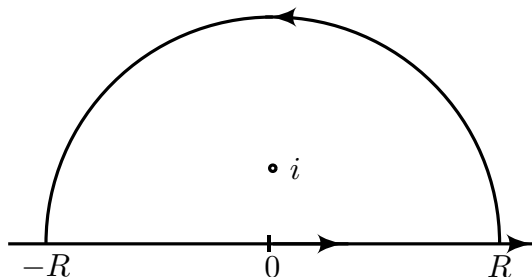

Figure 7.1

For $R > 1$ the path surrounds the pole $z = i$ for the meromorphic function $f(z) = z^2/(z^2 + 1)^2$, which has the residue $-i/4$ at $z = i$, cf. Example 7.2 (iv). We therefore have

$$\int_{-R}^R \frac{x^2}{(1+x^2)^2} dx + \int_0^\pi \frac{R^2 e^{2it}}{(1+R^2 e^{2it})^2} Rie^{it} dt = 2\pi i \left(-\frac{i}{4} \right) = \frac{\pi}{2}.$$

The absolute value of the integrand in $\int_0^\pi \dots$ is

$$\frac{R^3}{|1+R^2 e^{2it}|^2} \leq \frac{R^3}{(R^2-1)^2},$$

showing that the second integral is majorized by

$$\pi \frac{R^3}{(R^2-1)^2},$$

which tends to 0 for $R \rightarrow \infty$. Hence

$$\int_{-\infty}^{\infty} \frac{x^2}{(x^2+1)^2} dx = \frac{\pi}{2}.$$

In general we have:

Theorem 7.8. *Let f be a rational function*

$$f(z) = \frac{p(z)}{q(z)} = \frac{a_0 + a_1 z + \dots + a_m z^m}{b_0 + b_1 z + \dots + b_n z^n}, \quad a_m \neq 0, b_n \neq 0,$$

and assume that $n \geq m + 2$ and that f has no poles on the real axis. Then

$$\int_{-\infty}^{\infty} f(x) dx = 2\pi i \sum_{j=1}^k \operatorname{Res}(f, z_j),$$

where z_1, \dots, z_k are the poles in the upper half-plane.

Proof. Since

$$\lim_{|z| \rightarrow \infty} z^{n-m} f(z) = \frac{a_m}{b_n}$$

there exists $R_0 > 0$ such that

$$|z|^{n-m} |f(z)| \leq M := \frac{|a_m|}{|b_n|} + 1 \quad \text{for } |z| \geq R_0,$$

or

$$|f(z)| \leq \frac{M}{|z|^2} \quad \text{for } |z| \geq \max(1, R_0).$$

Choosing $R > 0$ bigger than $\max(1, R_0)$ and so big that $K(0, R)$ contains all poles of f in the upper half-plane, we have

$$\int_{-R}^R f(x) dx + \int_0^{\pi} f(Re^{i\theta}) iRe^{i\theta} d\theta = 2\pi i \sum_{j=1}^k \operatorname{Res}(f, z_j).$$

The absolute value of the second integral is majorized by $\pi R(M/R^2)$, which tends to 0 for $R \rightarrow \infty$, and therefore the integral $\int_{-R}^R f(x) dx$ tends to the right-hand side, which is independent of R . \square

Remark 7.9. If w_1, \dots, w_l denote the poles of f in the lower half-plane, then analogously

$$\int_{-\infty}^{\infty} f(x) dx = -2\pi i \sum_{j=1}^l \operatorname{Res}(f, w_j).$$

The method of Theorem 7.8 can be applied to other meromorphic functions than rational, provided that the integral over the half-circle tends to 0 for $R \rightarrow \infty$.

The following theorem can be used to calculate integrals for the form

$$\int_{-\infty}^{\infty} f(x) e^{i\lambda x} dx,$$

which are called *Fourier integrals*.

Theorem 7.10. *Let f be meromorphic in \mathbb{C} without poles on the real axis and with only finitely many poles z_1, \dots, z_k in the upper half-plane. If*

$$\max_{0 \leq t \leq \pi} |f(Re^{it})| \rightarrow 0 \quad \text{for } R \rightarrow \infty,$$

then

$$\lim_{R \rightarrow \infty} \int_{-R}^R f(x)e^{i\lambda x} dx = 2\pi i \sum_{j=1}^k \text{Res}(f(z)e^{i\lambda z}, z_j) \quad \text{for } \lambda > 0.$$

Proof. We consider the simple closed path consisting of the segment $[-R, R]$ and the half-circle $|z| = R, \text{Im } z \geq 0$ oriented counterclockwise, and we consider only R so big that the path encloses all the poles z_1, \dots, z_k . Applying Cauchy's residue theorem to $f(z)e^{i\lambda z}$, we find

$$\int_{-R}^R f(x)e^{i\lambda x} dx + \int_0^\pi f(Re^{it})e^{i\lambda Re^{it}} iRe^{it} dt = 2\pi i \sum_{j=1}^k \text{Res}(f(z)e^{i\lambda z}, z_j).$$

The absolute value of the second integral is majorized by

$$I = \max_{0 \leq t \leq \pi} |f(Re^{it})| \int_0^\pi Re^{-\lambda R \sin t} dt,$$

but using $\sin t \geq \frac{2}{\pi}t$ for $t \in [0, \frac{\pi}{2}]$, see the Figure 7.2,

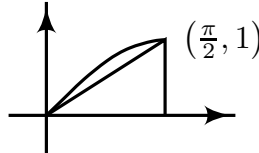

Figure 7.2

we get¹⁵ with $a = 2\lambda R/\pi$:

$$\begin{aligned} \int_0^\pi e^{-\lambda R \sin t} dt &= 2 \int_0^{\pi/2} e^{-\lambda R \sin t} dt \leq 2 \int_0^{\pi/2} e^{-at} dt \\ &= \frac{2}{a} (1 - e^{-a\frac{\pi}{2}}) < \frac{2}{a} = \frac{\pi}{\lambda R}, \end{aligned}$$

hence

$$I \leq \frac{\pi}{\lambda} \max_{0 \leq t \leq \pi} |f(Re^{it})|,$$

which tends to 0 for $R \rightarrow \infty$, and the theorem is proved. \square

¹⁵The integral is split in integrals over $[0, \pi/2]$ and $[\pi/2, \pi]$, and the last integral is transformed using $\sin t = \sin(\pi - t)$.

Remark 7.11. If w_1, \dots, w_l denote the poles of f in the lower half-plane, and the half-circle lies there, then we have to assume that

$$\max_{\pi \leq t \leq 2\pi} |f(Re^{it})| \rightarrow 0 \quad \text{for } R \rightarrow \infty,$$

and we get in an analogous way that

$$\lim_{R \rightarrow \infty} \int_{-R}^R f(x)e^{i\lambda x} dx = -2\pi i \sum_{j=1}^l \text{Res}(f(z)e^{i\lambda z}, w_j) \quad \text{for } \lambda < 0.$$

Example 7.12. We shall prove that

$$\lim_{R \rightarrow \infty} \int_{-R}^R \frac{x \sin \lambda x}{x^2 + 1} dx = \pi e^{-\lambda} \quad \text{for } \lambda > 0.$$

The function $f(z) = z/(z^2 + 1)$ is meromorphic with the poles $z = \pm i$ and

$$\text{Res}(f(z)e^{i\lambda z}, i) = \frac{1}{2}e^{-\lambda}.$$

The inequality

$$\max_{0 \leq t \leq \pi} |f(Re^{it})| \leq \frac{R}{R^2 - 1} \quad \text{for } R > 1$$

shows that the conditions of Theorem 7.10 are satisfied, hence

$$\lim_{R \rightarrow \infty} \int_{-R}^R \frac{x e^{i\lambda x}}{x^2 + 1} dx = \pi i e^{-\lambda} \quad \text{for } \lambda > 0,$$

and taking the imaginary part, we get the result. (Taking the real part leads to

$$\lim_{R \rightarrow \infty} \int_{-R}^R \frac{x \cos(\lambda x)}{x^2 + 1} dx = 0,$$

which is obvious.)

Example 7.13. We shall prove that

$$\lim_{R \rightarrow \infty} \int_{-R}^R \frac{\sin x}{x} dx = \pi.$$

Define $f(z) = e^{iz}/z$. Then f has a simple pole at $z = 0$ with the residue 1.

We next integrate f along the positively oriented path of Figure 7.3, and the result is $2\pi i$ by the residue theorem. The small half-circle with the parameterization

$$c_r(t) = r e^{it}, \quad t \in [-\pi, 0]$$

contributes with the amount

$$\int_{c_r} \frac{e^{iz}}{z} dz = \int_{c_r} \frac{dz}{z} + \int_{c_r} \frac{e^{iz} - 1}{z} dz = i\pi + \alpha(r),$$

but since

$$\varphi(z) = \frac{e^{iz} - 1}{z} \rightarrow i \quad \text{for } z \rightarrow 0,$$

(e.g. by l'Hospital's rule), there exists $r_0 > 0$ such that $|\varphi(z)| \leq 2$ for $|z| \leq r_0$, hence $|\alpha(r)| \leq 2\pi r$ for $r \leq r_0$. This shows that $\lim_{r \rightarrow 0} \alpha(r) = 0$, hence

$$\lim_{r \rightarrow 0} \int_{c_r} \frac{e^{iz}}{z} dz = i\pi.$$

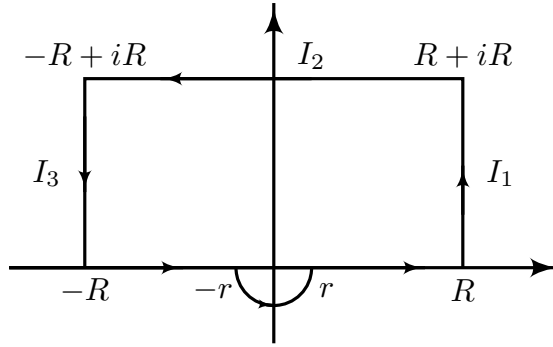

Figure 7.3

The integral I_1 along the vertical side $z = R + it$, $t \in [0, R]$ is

$$I_1 = \int_0^R \frac{e^{iR-t}}{R+it} i dt,$$

hence

$$|I_1| \leq \int_0^R \frac{e^{-t}}{R} dt \leq \frac{1}{R} \int_0^\infty e^{-t} dt = \frac{1}{R} \rightarrow 0 \quad \text{for } R \rightarrow \infty.$$

The integral I_2 along the upper side $z = -t + iR$, $t \in [-R, R]$ is

$$I_2 = - \int_{-R}^R \frac{e^{-it-R}}{-t+iR} dt,$$

hence

$$|I_2| \leq e^{-R} \int_{-R}^R \frac{dt}{R} = 2e^{-R} \rightarrow 0 \quad \text{for } R \rightarrow \infty.$$

The integral I_3 along the vertical side $z = -R + i(R - t)$, $t \in [0, R]$ is

$$I_3 = -i \int_0^R \frac{e^{-iR+t-R}}{-R + i(R-t)} dt,$$

hence

$$|I_3| \leq \frac{1}{R} \int_0^R e^{t-R} dt \leq \frac{1}{R} \rightarrow 0 \text{ for } R \rightarrow \infty.$$

Using that

$$I_1 + I_2 + I_3 + \int_{-R}^{-r} + \int_r^R \frac{e^{ix}}{x} dx + i\pi + \alpha(r) = 2\pi i,$$

we get by taking the imaginary part and letting $r \rightarrow 0$

$$\text{Im}(I_1 + I_2 + I_3) + \int_{-R}^R \frac{\sin x}{x} dx + \pi = 2\pi.$$

Finally, by letting $R \rightarrow \infty$, we get (remembering $I_j \rightarrow 0$ for $j = 1, 2, 3$)

$$\lim_{R \rightarrow \infty} \int_{-R}^R \frac{\sin x}{x} dx = \pi,$$

hence

$$\int_{-\infty}^{\infty} \frac{\sin x}{x} dx = \pi, \quad \int_0^{\infty} \frac{\sin x}{x} dx = \frac{\pi}{2}.$$

We notice that the integrals are *improper* in the sense that the integral of the absolute value diverges:

$$\int_{-\infty}^{\infty} \left| \frac{\sin x}{x} \right| dx = \infty.$$

The latter follows by comparison with the harmonic series because

$$\begin{aligned} \int_0^{\infty} \frac{|\sin x|}{x} dx &\geq \sum_{k=1}^n \int_{(k-1)\pi}^{k\pi} \frac{|\sin x|}{x} dx \geq \sum_{k=1}^n \frac{1}{k\pi} \int_{(k-1)\pi}^{k\pi} |\sin x| dx \\ &= \frac{2}{\pi} \sum_{k=1}^n \frac{1}{k}. \end{aligned}$$

To evaluate an integral of the form

$$\int_0^{2\pi} f(\cos t, \sin t) dt,$$

one can try to rewrite it as a path integral over the unit circle

$$\int_{\partial K(0,1)} f\left(\frac{1}{2}\left(z + \frac{1}{z}\right), \frac{1}{2i}\left(z - \frac{1}{z}\right)\right) \frac{1}{iz} dz$$

using that $z = e^{it}$, $t \in [0, 2\pi]$ is a parameterization. We next try to evaluate this integral by the residue theorem.

Example 7.14. Evaluate

$$I(a) = \int_0^{2\pi} \frac{dt}{a + \cos t} \quad \text{for } a > 1.$$

We find

$$I(a) = \int_{\partial K(0,1)} \frac{dz}{iz(a + \frac{1}{2}(z + \frac{1}{z}))} = -2i \int_{\partial K(0,1)} \frac{dz}{z^2 + 2az + 1}.$$

The polynomial in the denominator has the zeros $p = -a + \sqrt{a^2 - 1}$, $q = -a - \sqrt{a^2 - 1}$, hence $q < -1 < p < 0$. The integrand has a simple pole $z = p$ in $K(0, 1)$ with the residue

$$\left[\frac{1}{2z + 2a} \right]_{z=p} = \frac{1}{2\sqrt{a^2 - 1}},$$

while $q \notin K(0, 1)$. By the residue theorem

$$I(a) = (-2i)(2\pi i) \frac{1}{2\sqrt{a^2 - 1}} = \frac{2\pi}{\sqrt{a^2 - 1}}.$$

7.4. Sums of infinite series.

Let f be meromorphic in \mathbb{C} . The meromorphic functions

$$f(z) \cot(\pi z), f(z)/\sin(\pi z)$$

have isolated singularities at $z = n \in \mathbb{Z}$ with

$$\begin{aligned} \operatorname{Res}(f(z) \cot(\pi z), n) &= \frac{f(n)}{\pi} \\ \operatorname{Res}(f(z)/\sin(\pi z), n) &= \frac{(-1)^n f(n)}{\pi}, \end{aligned}$$

provided that f does not have a pole at $z = n$.

If $f(n) = 0$, then $z = n$ is in fact a removable singularity and the residue is 0. If $z = n$ is a pole of f , then we have to modify the expression for the residue, since the pole becomes multiple.

Let $\gamma_{m,n}$ denote a simple closed path surrounding the poles $-m, -m + 1, \dots, 0, 1, \dots, n$ counterclockwise, where $m, n \in \mathbb{N}_0$. For $f \in \mathcal{H}(\mathbb{C})$ we have

$$\int_{\gamma_{m,n}} f(z) \cot(\pi z) dz = 2i \sum_{k=-m}^n f(k) \quad (1)$$

$$\int_{\gamma_{m,n}} \frac{f(z)}{\sin(\pi z)} dz = 2i \sum_{k=-m}^n (-1)^k f(k). \quad (2)$$

If we can find the limit of the left-hand sides for $m, n \rightarrow \infty$, we get expressions for the sums

$$\sum_{-\infty}^{\infty} f(k), \quad \sum_{-\infty}^{\infty} (-1)^k f(k).$$

If we can find the limits when $m = 0$ and for $n \rightarrow \infty$, we similarly get expressions for the sums

$$\sum_0^{\infty} f(k), \quad \sum_0^{\infty} (-1)^k f(k).$$

If f has poles, then the right-hand sides of (1) and (2) have to be modified.

As a closed path we choose the boundary of the rectangle

$$F_{m,n} = \{z = x + iy \mid -\left(m + \frac{1}{2}\right) \leq x \leq n + \frac{1}{2}, |y| \leq n + m\}, \quad n, m \geq 1.$$

Using

$$\sin(\pi z) = \sin(\pi x) \cosh(\pi y) + i \cos(\pi x) \sinh(\pi y),$$

cf. exc. 1.12, we get the following estimates on the vertical sides of $F_{m,n}$

$$|\sin(\pi z)| = \cosh(\pi y) = \frac{1}{2} (e^{\pi y} + e^{-\pi y}) \geq \frac{1}{2} e^{\pi|y|},$$

hence

$$\frac{1}{|\sin(\pi z)|} \leq 2e^{-\pi|y|} \leq 2. \quad (3)$$

On the horizontal sides $y = \pm(n + m)$ of $F_{m,n}$ we have

$$\begin{aligned} |\sin(\pi z)|^2 &= \sin^2(\pi x) \cosh^2(\pi y) + \cos^2(\pi x) \sinh^2(\pi y) \\ &= \sin^2(\pi x)(1 + \sinh^2(\pi y)) + \cos^2(\pi x) \sinh^2(\pi y) \\ &= \sin^2(\pi x) + \sinh^2(\pi y) \\ &\geq \sinh^2(\pi y) = \sinh^2(\pi(n + m)), \end{aligned}$$

hence

$$\frac{1}{|\sin(\pi z)|} \leq \frac{1}{\sinh(\pi(n + m))} \leq \frac{1}{\sinh(2\pi)}. \quad (4)$$

Example 7.15. Let $f(z) = 1/z^2$. The function $1/(z^2 \sin(\pi z))$ has a pole of third order at $z = 0$ with the residue $\pi/6$ (see below), while $z = k \in \mathbb{Z} \setminus \{0\}$ is a simple pole with the residue $(-1)^k/(\pi k^2)$. By the residue theorem we then get

$$\int_{\partial F_{m,n}} \frac{dz}{z^2 \sin(\pi z)} = 2\pi i \frac{\pi}{6} + 2i \sum_{\substack{k=-m \\ k \neq 0}}^n \frac{(-1)^k}{k^2}. \quad (5)$$

Since $(-1)^k/k^2$ has the same value for $\pm k$, $k \in \mathbb{N}$, it is convenient to put $m = n$. The length of the rectangle $F_{n,n}$ is

$$L(\partial F_{n,n}) = 2(2n + 1) + 8n = 12n + 2,$$

and for $z \in \partial F_{n,n}$ we have $|z| > n$.

From (3) and (4) we see that

$$\frac{1}{|\sin(\pi z)|} \leq 2 \text{ for } z \in \partial F_{n,n},$$

hence by the estimation lemma 2.8

$$\left| \int_{\partial F_{n,n}} \frac{dz}{z^2 \sin(\pi z)} \right| \leq \frac{2}{n^2} (12n + 2) \rightarrow 0 \text{ for } n \rightarrow \infty,$$

and we finally get by (5) that

$$\sum_{k=1}^{\infty} \frac{(-1)^{k-1}}{k^2} = \frac{\pi^2}{12}. \quad (6)$$

Evaluation of the residue $\text{Res}(1/(z^2 \sin(\pi z)), 0)$.

We calculate the first terms of the power series of $z/\sin z$. Using that it is an even function with the value 1 at the removable singularity $z = 0$, we can write

$$\frac{z}{\sin z} = 1 + k_1 z^2 + k_2 z^4 + \dots$$

Multiplying this power series by the well-known power series

$$\frac{\sin z}{z} = 1 - \frac{z^2}{6} + \frac{z^4}{5!} - \dots$$

we get

$$1 = 1 + \left(k_1 - \frac{1}{6}\right) z^2 + \left(k_2 - \frac{k_1}{6} + \frac{1}{5!}\right) z^4 + \dots,$$

hence $k_1 - \frac{1}{6} = 0$, $k_2 - \frac{k_1}{6} + \frac{1}{5!} = 0, \dots$, leading to $k_1 = \frac{1}{6}$, $k_2 = \frac{7}{360}$.

This gives

$$\frac{1}{z^2 \sin(\pi z)} = \frac{1}{\pi z^3} \left(1 + \frac{\pi^2}{6} z^2 + k_2 \pi^4 z^4 + \dots \right),$$

from where we can read off that the residue is $\frac{\pi}{6}$.

As the last application of the residue theorem we will prove Euler's *partial fraction decomposition* of $1/\sin z$.

Theorem 7.16. For $z \in \mathbb{C} \setminus \pi\mathbb{Z}$

$$\frac{1}{\sin z} = \sum_{p=-\infty}^{\infty} \frac{(-1)^p}{z - p\pi} = \frac{1}{z} + 2z \sum_{p=1}^{\infty} \frac{(-1)^p}{z^2 - p^2\pi^2}.$$

More precisely we have

$$\sum_{p=-m}^n \frac{(-1)^p}{z - p\pi} \rightarrow \frac{1}{\sin z} \quad \text{for } n, m \rightarrow \infty,$$

uniformly for z in every bounded subset of $\mathbb{C} \setminus \pi\mathbb{Z}$.

Proof. Fix $a \in \mathbb{C} \setminus \mathbb{Z}$ and consider $f(z) = 1/(z - a)$. Then

$$\frac{1}{(z - a) \sin(\pi z)},$$

has simple poles at $z = a$ and $z = k \in \mathbb{Z}$, the residues being

$$\frac{1}{\sin(\pi a)} \quad \text{and} \quad \frac{(-1)^k}{\pi(k - a)}.$$

Integrating along the boundary of the rectangle $F_{m,n}$ above, moving counterclockwise, where $m, n \in \mathbb{N}$ are chosen so big that a is an interior point of $F_{m,n}$, we get

$$I = \frac{1}{2\pi i} \int_{\partial F_{m,n}} \frac{dz}{(z - a) \sin(\pi z)} = \frac{1}{\sin(\pi a)} - \sum_{k=-m}^n \frac{(-1)^k}{\pi(a - k)}.$$

We shall prove that $I \rightarrow 0$ for $n, m \rightarrow \infty$, uniformly for a belonging to a bounded subset of $\mathbb{C} \setminus \mathbb{Z}$.

By (3) and (4) we get

$$|I| \leq \frac{1}{2\pi} \sup \left\{ \frac{1}{|z - a|} \mid z \in \partial F_{m,n} \right\} \left(4 \int_{-(n+m)}^{n+m} e^{-\pi|y|} dy + 2 \frac{n+m+1}{\sinh \pi(n+m)} \right),$$

and since

$$4 \int_{-(n+m)}^{n+m} e^{-\pi|y|} dy = 8 \int_0^{n+m} e^{-\pi y} dy \leq \frac{8}{\pi} \text{ and } \sup \left\{ \frac{x+1}{\sinh(\pi x)} \mid x \geq 2 \right\} < \infty,$$

there exists a constant K , independent of n and m , such that

$$|I| \leq K \sup \left\{ \frac{1}{|z-a|} \mid z \in \partial F_{m,n} \right\}.$$

Assume now that $a \in K(0, R) \setminus \mathbb{Z}$, where R is fixed and consider $m, n > R$. For $z \in \partial F_{m,n}$ we have $|z-a| > \min(m, n) - R$, hence

$$|I| < \frac{K}{\min(m, n) - R} \rightarrow 0$$

uniformly for $a \in K(0, R) \setminus \mathbb{Z}$ when $m, n \rightarrow \infty$. This shows what we wanted to prove, hence

$$\frac{1}{\sin(\pi a)} = \sum_{k=-\infty}^{\infty} \frac{(-1)^k}{\pi(a-k)}.$$

Replacing a by $\frac{z}{\pi}$ we get the original formula. □

Exercises for §7

7.1. Find the poles, their order and the corresponding residues of

$$f(z) = \frac{1}{z(z-1)^2}, \quad f(z) = \frac{1}{z(z+1)^3}, \quad f(z) = \frac{1}{e^{z^2} - 1}.$$

7.2. (This exercise requires exc. 6.3.) Let $h : \mathbb{C} \rightarrow \mathbb{C} \cup \{\infty\}$ be a meromorphic function with P being the set of poles.

1° Prove that the reflected function $h^* : \mathbb{C} \rightarrow \mathbb{C} \cup \{\infty\}$ defined by

$$h^*(z) = \begin{cases} \overline{h(\bar{z})}, & \text{for } z \notin P^* \\ \infty, & \text{for } z \in P^* \end{cases}$$

is a meromorphic function with the set of poles $P^* = \{p | \bar{p} \in P\}$.

2° If a is a pole of order m of h with the principal part

$$\sum_{j=1}^m \frac{c_j}{(z-a)^j},$$

then \bar{a} is a pole of h^* of the same order and with the principal part

$$\sum_{j=1}^m \frac{\bar{c}_j}{(z-\bar{a})^j},$$

and in particular $\text{Res}(h^*, \bar{a}) = \overline{\text{Res}(h, a)}$ for $a \in P$.

3° Prove that $\mathbb{C} \setminus (P \cup P^*)$ is a reflection invariant domain. *Hint.* Use exc. 5.15.

4° Prove that $h(\mathbb{R} \setminus P) \subseteq \mathbb{R}$ if and only if $P = P^*$ and $h = h^*$.

7.3. Let $f, g \in \mathcal{H}(G)$ and assume that f has a zero of order $n > 0$ at $a \in G$ and that g has a zero of order $n + 1$ at a . Prove that

$$\text{Res}\left(\frac{f}{g}, a\right) = (n+1) \frac{f^{(n)}(a)}{g^{(n+1)}(a)}.$$

7.4. Let $h : G \rightarrow \mathbb{C} \cup \{\infty\}$ be meromorphic in the simply connected domain G , let $\varphi \in \mathcal{H}(G)$ and let γ be a positively oriented simple closed path in G , not passing through any zeros and poles of h . Assume that γ encloses the

zeros a_1, \dots, a_p and the poles b_1, \dots, b_q of h , each of them repeated as often as the multiplicity indicates.

Prove that

$$\frac{1}{2\pi i} \int_{\gamma} \frac{h'(z)}{h(z)} \varphi(z) dz = \sum_{j=1}^p \varphi(a_j) - \sum_{j=1}^q \varphi(b_j).$$

7.5. Prove that

$$\frac{1}{2\pi i} \int_{\partial K(0, n+\frac{1}{2})} z^{2k} \cot(\pi z) dz = \frac{2}{\pi} \sum_{j=1}^n j^{2k}.$$

for $n, k \in \mathbb{N}$.

7.6. Prove that

$$\int_{-\infty}^{\infty} \frac{dx}{1+x^4} = \frac{\pi}{\sqrt{2}}.$$

7.7. Prove that $\int_{-\infty}^{\infty} \frac{x^2}{(x^2+1)(x^2+4)} dx = \frac{\pi}{3}$.

7.8. Prove that $\int_{-\infty}^{\infty} \frac{e^{i\pi x}}{x^2-2x+2} dx = -\pi e^{-\pi}$.

7.9. Prove that $\int_0^{2\pi} \frac{\cos x}{a+\cos x} dx = 2\pi \left(1 - \frac{a}{\sqrt{a^2-1}}\right)$ for $a > 1$.

7.10. Prove that

$$\int_0^{\infty} \frac{x^{p-1}}{1+x^{2n}} dx = \frac{\pi}{2n \sin \frac{p\pi}{2n}}, \quad p, n \in \mathbb{N}, 1 \leq p < 2n.$$

Hint. Integrate along the boundary of the sector $z = |z|e^{i\theta}$, $|z| \leq R$, $0 \leq \theta \leq \frac{\pi}{n}$.

7.11. Prove that

$$\int_{-\infty}^{\infty} \frac{e^{ax}}{1+e^x} dx = \frac{\pi}{\sin(a\pi)} \quad \text{for } 0 < a < 1.$$

Hint. Integrate along the boundary of the rectangle with vertices $z = \pm R$, $z = \pm R + 2\pi i$.

7.12. Prove that

$$\int_0^{\infty} x^{4n+3} e^{-x} \sin x \, dx = 0 \text{ for } n = 0, 1, 2, \dots$$

Hint. Integrate $f(z) = z^{4n+3} e^{-z}$ along the boundary of the sector $z = |z|e^{i\theta}$, $0 \leq |z| \leq R$, $0 \leq \theta \leq \frac{\pi}{4}$.

Prove that

$$\int_0^{\infty} t^n e^{-\sqrt[4]{t}} \sin \sqrt[4]{t} \, dt = 0, \quad n = 0, 1, 2, \dots$$

For every $c \in [-1, 1]$ consider the measure μ_c on $[0, \infty[$ having the non-negative density $(1 + c \sin \sqrt[4]{t})e^{-\sqrt[4]{t}}$ with respect to Lebesgue measure. Prove that all the measures μ_c have the same moments

$$\int_0^{\infty} x^n d\mu_c(x) = 4(4n + 3)!$$

(This is the example of Stieltjes of an *indeterminate* moment problem, i.e. that different measures on $[0, \infty[$ can have the same moments.)

7.13. Prove that

$$\int_{-\infty}^{\infty} \frac{e^{i\lambda x}}{1+x^2} dx = \pi e^{-|\lambda|}, \quad \lambda \in \mathbb{R}.$$

7.14. Prove that

$$|\cot z|^2 = \frac{\cos^2 x + \sinh^2 y}{\sin^2 x + \sinh^2 y} \text{ for } z = x + iy \in \mathbb{C} \setminus \pi\mathbb{Z}$$

and use it to conclude that $|\cot(\pi z)| < 2$ for $z \in \partial F_{n,n}$ in the notation from §7.4.

Prove that

$$\sum_{k=1}^{\infty} \frac{1}{k^{2p}} = -\frac{\pi}{2} \operatorname{Res} \left(\frac{\cot(\pi z)}{z^{2p}}, 0 \right) \quad p \in \mathbb{N}.$$

Calculate the residue using exc. 6.13 and prove Euler's formula

$$\sum_{k=1}^{\infty} \frac{1}{k^{2p}} = (-1)^{p-1} \frac{B_{2p}}{2(2p)!} (2\pi)^{2p}.$$

7.15. Let $f \in \mathcal{H}(G)$ be non-constant in the domain G . Fix $z_0 \in G$ and let $f(z_0) = w_0$. Prove that there exists $r > 0$ with $\overline{K(z_0, r)} \subseteq G$ and such that

- (i) $f(z) \neq w_0$ for $z \in \overline{K(z_0, r)} \setminus \{z_0\}$.
- (ii) $f'(z) \neq 0$ for $z \in \overline{K(z_0, r)} \setminus \{z_0\}$.

Assume that the zero z_0 of $f(z) - w_0$ has order $k \geq 2$.

Recall the proof of Theorem 7.6 and define $\Gamma(t) = f(z_0 + re^{it})$, $t \in [0, 2\pi]$ and $\rho > 0$ such that $K(w_0, \rho) \cap \Gamma^* = \emptyset$.

Prove that for every $w \in K(w_0, \rho)$ the function $f(z) - w$ has k simple zeros in $K(z_0, r)$.

Explain that the following theorem has been proved:

Let $f \in \mathcal{H}(G)$ be one-to-one (injective) on the domain G . Then $f'(z) \neq 0$ for all $z \in G$.

Comment. By Theorem 7.6 we know that $f(G)$ is open and $f : G \rightarrow f(G)$ is an open mapping. Use this to prove that $f^{\circ -1}$ is continuous and prove next that it is also holomorphic, hence Theorem 1.4 has been proved, when G is a domain.

7.16. Let f be holomorphic in the domain G . Fix $z_0 \in G$, let $f(z_0) = w_0$ and assume that $f'(z_0) \neq 0$.

Prove that there exist an open set \mathcal{U} such that $z_0 \in \mathcal{U} \subseteq G$ and a $\rho > 0$ such that f maps \mathcal{U} bijectively onto $K(w_0, \rho)$.

Hint. Make use of the proof of Theorem 7.6.

7.17. Let f be a non-constant holomorphic function in the domain G . Fix $z_0 \in G$, let $f(z_0) = w_0$ and assume that $f'(z_0) = \dots = f^{(k-1)}(z_0) = 0$, $f^{(k)}(z_0) \neq 0$ for some $k \geq 1$. Prove that there exist an open set \mathcal{U} such that $z_0 \in \mathcal{U} \subseteq G$ and a holomorphic function $h : \mathcal{U} \rightarrow \mathbb{C}$ satisfying $h(z_0) = 0$, $h'(z_0) \neq 0$ such that

$$f(z) = w_0 + (h(z))^k \text{ for } z \in \mathcal{U}.$$

Hint. Make use of the Taylor expansion

$$f(z) = w_0 + \sum_{n=k}^{\infty} \frac{f^{(n)}(z_0)}{n!} (z - z_0)^n = w_0 + (z - z_0)^k f_1(z)$$

for $|z - z_0| < r$ for r sufficiently small and $f_1 \in \mathcal{H}(K(z_0, r))$ is such that $f_1(z_0) \neq 0$.

Prove that two differentiable curves, intersecting each other at z_0 under the angle α , are mapped by f in two curves intersecting each other at w_0 under the angle $k\alpha$.

Hint. Compare with §1.2.

7.18. Let $a \in \mathbb{C}$ satisfy $|a| > e$ and let $n \in \mathbb{N}$. Prove that $g(z) = az^n - e^z$ has precisely n different zeros in $K(0, 1)$.

Hint. Apply Rouché's theorem with $f(z) = az^n$.

7.19. Consider the polynomial $p(z) = z^7 - 5z^4 + z^2 - 2$.

- (i) Prove that p has 7 zeros in $|z| < 2$.
- (ii) Prove that p has 4 zeros in $|z| < 1$.
- (iii) Prove that p has no zeros on $|z| = 1$ and conclude that p has 3 zeros in the annulus $1 < |z| < 2$.

7.20. Let

$$p(z) = \prod_{j=1}^k (z - a_j)^{m_j}$$

be a polynomial and assume that its zeros a_1, \dots, a_k are different complex numbers, $m_j \in \mathbb{N}$ being the multiplicity of the zero a_j .

- (i) Prove that

$$\frac{p'(z)}{p(z)} = \sum_{j=1}^k \frac{m_j}{z - a_j}, \quad z \in \mathbb{C} \setminus \{a_1, \dots, a_k\}.$$

- (ii) Show that if $z \notin \{a_1, \dots, a_k\}$ satisfies $p'(z) = 0$, then

$$z \left(\sum_{j=1}^k c_j \right) = \sum_{j=1}^k c_j a_j, \quad \text{with } c_j = \frac{m_j}{|z - a_j|^2}.$$

- (iii) Interpret (ii) in the following way: Any zero of p' belongs to the smallest convex polygon in \mathbb{C} containing a_1, \dots, a_k (=the convex hull of $\{a_1, \dots, a_k\}$). The result is due to Gauss.

§8. The maximum modulus principle

In this section we give two versions of the maximum modulus principle: a local and a global. The latter is used to give a proof of Schwarz's lemma, which in turn is applied to prove a complete description of the automorphism group of holomorphic bijections $f : K(0, 1) \rightarrow K(0, 1)$. We also determine the holomorphic bijections of \mathbb{C} .

Theorem 8.1. The maximum modulus principle. Local version.

Let $f : G \rightarrow \mathbb{C}$ be a non-constant holomorphic function in a domain G . Then $|f|$ does not have a local maximum in G .

Proof. We will prove the following equivalent assertion for $f \in \mathcal{H}(G)$:

If $|f|$ has a local maximum in G , then f is constant.

Assume therefore that $|f|$ has a local maximum at some point $a \in G$. This means that there exists $r > 0$ such that $K(a, r) \subseteq G$ and

$$|f(z)| \leq |f(a)| \text{ for } z \in K(a, r). \quad (1)$$

By Cauchy's integral formula

$$f(a) = \frac{1}{2\pi i} \int_{\partial K(a, s)} \frac{f(z)}{z - a} dz$$

for $0 < s < r$. Inserting the parameterization $z = a + se^{i\theta}$, $\theta \in [0, 2\pi]$, we get

$$f(a) = \frac{1}{2\pi} \int_0^{2\pi} f(a + se^{i\theta}) d\theta,$$

hence

$$|f(a)| \leq \frac{1}{2\pi} \int_0^{2\pi} |f(a + se^{i\theta})| d\theta. \quad (2)$$

By (1) we have

$$|f(a + se^{i\theta})| \leq |f(a)|$$

for $0 < s < r$, $\theta \in [0, 2\pi]$, hence

$$0 \leq \frac{1}{2\pi} \int_0^{2\pi} (|f(a)| - |f(a + se^{i\theta})|) d\theta = |f(a)| - \frac{1}{2\pi} \int_0^{2\pi} |f(a + se^{i\theta})| d\theta \leq 0,$$

where the last inequality sign follows by (2). This shows that the continuous non-negative function in θ

$$\phi_s(\theta) = |f(a)| - |f(a + se^{i\theta})|$$

has integral 0 over the interval $[0, 2\pi]$, but then it has to be identically 0. Therefore

$$|f(a + se^{i\theta})| = |f(a)|, \quad 0 < s < r, \theta \in [0, 2\pi],$$

i.e. $|f|$ is constant in $K(a, r)$. By exc. 1.7 we get that f is constant in $K(a, r)$, and by the identity theorem f is constant in G . \square

Theorem 8.2. The maximum modulus principle. Global version.

Let G be a bounded domain in \mathbb{C} and assume that $f : \overline{G} \rightarrow \mathbb{C}$ is continuous and that f is holomorphic in G .

The supremum

$$M = \sup\{|f(z)| \mid z \in \overline{G}\}$$

is attained at a point on the boundary of G , but not in any point of G unless f is constant in G .

Proof. By Theorem A.3 there exists $z_0 \in \overline{G}$ such that

$$|f(z_0)| = \sup\{|f(z)| \mid z \in \overline{G}\} = M.$$

Assume first that f is non-constant in G . Then $z_0 \in \partial G$ because otherwise $z_0 \in G$ and then $|f|$ has a local maximum at z_0 , contradicting Theorem 8.1.

Assume next that f is constant ($= \lambda$) in G . Then the pre-image

$$\{z \in \overline{G} \mid f(z) = \lambda\}$$

is closed in \overline{G} and contains G , hence is equal to \overline{G} . This means that $M = |\lambda|$ is attained at all points of \overline{G} and in particular at the boundary of G , which is non-empty.¹⁶ \square

For a holomorphic function $f : K(0, \rho) \rightarrow \mathbb{C}$, where $0 < \rho \leq \infty$ we define the *maximum modulus* $M_f : [0, \rho[\rightarrow [0, \infty[$ by

$$M_f(r) = \max\{|f(z)| \mid |z| = r\}, \quad 0 \leq r < \rho. \quad (3)$$

By Theorem 8.2 we get

$$M_f(r) = \max\{|f(z)| \mid |z| \leq r\},$$

but this implies that M_f is an increasing function, even *strictly increasing* unless f is constant.

The function M_f is particularly important in the study of entire functions f .

As an application of the maximum modulus principle we will prove a useful result by the German mathematician H.A. Schwarz (1843-1921), also known for the Cauchy-Schwarz inequality.

¹⁶Otherwise G would be open and closed hence either empty or equal to \mathbb{C} , since \mathbb{C} is connected in the sense of general topology.

Theorem 8.3. Schwarz's lemma. *Let $f : K(0, 1) \rightarrow K(0, 1)$ be holomorphic with $f(0) = 0$. Then*

- (i) $|f(z)| \leq |z|$, $|z| < 1$.
- (ii) $|f'(0)| \leq 1$.

If there is equality sign in (i) for some $z \neq 0$ or in (ii), then $f(z) = \lambda z$ for some $\lambda \in \mathbb{C}$ satisfying $|\lambda| = 1$. (In other words, f is a rotation around zero by the angle $\arg(\lambda)$).

Proof. The function $f(z)/z$ is holomorphic in $K'(0, 1)$ with a removable singularity at $z = 0$, because

$$\lim_{z \rightarrow 0} \frac{f(z)}{z} = f'(0)$$

exists. Therefore the function

$$g(z) = \begin{cases} f(z)/z, & 0 < |z| < 1 \\ f'(0), & z = 0 \end{cases}$$

is holomorphic in $K(0, 1)$.

Let $|z| < 1$ be fixed and let r be arbitrary such that $|z| \leq r < 1$. The global version of the maximum modulus principle applied to g and to $G = K(0, r)$ gives

$$|g(z)| \leq \max \left\{ \left| \frac{f(z)}{z} \right| \mid |z| = r \right\} = \frac{|f(z_0)|}{r} < \frac{1}{r},$$

for some $|z_0| = r$. Using that $r \in [|z|, 1[$ is arbitrary, we get $|g(z)| \leq 1$ by letting $r \rightarrow 1$. In particular

$$|f(z)| \leq |z| \quad \text{and} \quad |f'(0)| \leq 1.$$

If the equality sign holds in one of the inequalities, then $|g|$ has a local maximum in $K(0, 1)$, hence $g \equiv \lambda$ for some constant λ satisfying $|\lambda| = 1$. \square

For $z_0 \in K(0, 1)$ we consider the rational function

$$f_{z_0}(z) = \frac{z - z_0}{1 - \bar{z}_0 z}, \tag{4}$$

which is holomorphic for $z \neq 1/\bar{z}_0$, in particular in $K(0, \rho)$ where $\rho = |1/\bar{z}_0| > 1$. Note that $f_0(z) = z$. On the unit circle we have

$$f_{z_0}(e^{i\theta}) = \frac{e^{i\theta} - z_0}{1 - \bar{z}_0 e^{i\theta}} = \frac{1}{e^{i\theta}} \frac{e^{i\theta} - z_0}{e^{-i\theta} - \bar{z}_0},$$

hence

$$\left| f_{z_0}(e^{i\theta}) \right| = 1,$$

because $|e^{i\theta} - z_0| = |e^{-i\theta} - \bar{z}_0|$. By the global version of the maximum modulus principle

$$\max_{|z| \leq 1} |f_{z_0}(z)| = 1,$$

but since f_{z_0} is non-constant, the maximum is not attained in $K(0, 1)$, showing that f_{z_0} maps $K(0, 1)$ into $K(0, 1)$.

Theorem 8.4. *For $z_0 \in K(0, 1)$ the function f_{z_0} given by (4) is a holomorphic bijection of $K(0, 1)$. The inverse mapping is f_{-z_0} .*

Proof. We shall prove that f_{z_0} is bijective and that $f_{z_0}^{\circ -1} = f_{-z_0}$. The equation

$$\frac{z - z_0}{1 - \bar{z}_0 z} = \omega$$

has the unique solution

$$z = \frac{\omega + z_0}{1 + \bar{z}_0 \omega} = f_{-z_0}(\omega),$$

and if $\omega \in K(0, 1)$, then $f_{-z_0}(\omega) \in K(0, 1)$ by the preamble to the theorem. \square

For a domain $G \subseteq \mathbb{C}$ we let $\text{Aut}(G)$ denote the set of holomorphic bijections $f : G \rightarrow G$. By Theorem 1.4, if $f \in \text{Aut}(G)$ then $f^{\circ -1}$ is holomorphic, hence $f^{\circ -1} \in \text{Aut}(G)$. Under composition of mappings $\text{Aut}(G)$ is a subgroup of the group of bijections of G . It is called the *automorphism group* of G . Using Schwarz's lemma it is easy to prove that

$$\text{Aut}(K(0, 1)) = \{\lambda f_{z_0} \mid |\lambda| = 1, |z_0| < 1\}, \quad (5)$$

cf. exc. 8.4.

We will now determine the holomorphic bijections $f : \mathbb{C} \rightarrow \mathbb{C}$.

Theorem 8.5. *The function $f(z) = az + b$ is a holomorphic bijection of \mathbb{C} provided $a, b \in \mathbb{C}, a \neq 0$, and every holomorphic bijection of \mathbb{C} has this form.*

Proof. It is easy to see that the given expression defines a holomorphic bijection, and the inverse has the same form, namely

$$f^{\circ -1}(z) = \frac{1}{a}z - \frac{b}{a}.$$

Assume next that $f \in \mathcal{H}(\mathbb{C})$ is a bijection of \mathbb{C} . Since f is entire it has a power series representation

$$f(z) = \sum_{n=0}^{\infty} a_n z^n, \quad z \in \mathbb{C}.$$

We first show indirectly that f has to be a polynomial. Assuming the contrary, i.e. $a_n \neq 0$ for infinitely many n , then the Laurent series

$$f\left(\frac{1}{z}\right) = \sum_{n=0}^{\infty} a_n z^{-n}, \quad z \neq 0$$

satisfies condition (iii) of Theorem 6.21, hence $z = 0$ is an essential singularity of $f(1/z)$. The set

$$T = \{f(1/z) \mid z \in K'(0, 1)\} = \{f(w) \mid w \in \mathbb{C}, |w| > 1\}$$

is dense in \mathbb{C} by the Casorati-Weierstrass Theorem 6.11. Moreover, $G = f(K(0, 1))$ is a non-empty open subset of \mathbb{C} by Theorem 7.6, and then $T \cap G \neq \emptyset$. A point $w \in T \cap G$ can be written $f(z_1) = f(z_2) = w$ with $|z_1| > 1, |z_2| < 1$, but this is contradicting the injectivity of f .

Having shown that f is a polynomial, also f' is a polynomial. Since f is one-to-one, we know by Theorem 1.4 that $f'(z) \neq 0$ for all $z \in \mathbb{C}$, but then f' must be a constant $a \neq 0$ by the fundamental theorem of algebra. Finally, $f(z) = az + b$. \square

Theorem 8.5 can be expressed

$$\text{Aut}(\mathbb{C}) = \{z \rightarrow az + b \mid a \in \mathbb{C} \setminus \{0\}, b \in \mathbb{C}\}. \quad (6)$$

Exercises for §8

8.1. Let $f : G \rightarrow \mathbb{C} \setminus \{0\}$ be a non-constant holomorphic function in the domain G . Prove that $|f|$ does not have a local minimum in G .

8.2. Let $f \in \mathcal{H}(\mathbb{C})$ and let G be a non-empty bounded domain in \mathbb{C} . Assume that

- 1) $|f(z)| \geq 1$ for $z \in \partial G$.
- 2) $\exists z_0 \in G : |f(z_0)| < 1$.

Prove that f has a zero in G .

8.3. Let R denote the rectangle

$$R = \{z = x + iy \mid 0 \leq x \leq 2\pi, 0 \leq y \leq 1\}.$$

Find $M = \sup\{|\sin(z)| \mid z \in R\}$ and determine the points $z_0 \in R$ such that $|\sin(z_0)| = M$.

8.4. Prove the following assertions about $\text{Aut}(K(0, 1))$:

(i) If $f \in \text{Aut}(K(0, 1))$ satisfies $f(0) = 0$, then $f(z) = \lambda z$ where $|\lambda| = 1$.

Hint. Apply Schwarz's lemma to f and to $f^{\circ-1}$.

(ii) If $f \in \text{Aut}(K(0, 1))$, then there exist $z_0 \in K(0, 1)$ and λ such that $|\lambda| = 1$ and

$$f(z) = \lambda f_{z_0}.$$

Hint. Let $z_0 \in K(0, 1)$ be determined by $f(z_0) = 0$. Apply (i) to $f_{z_0} \circ f^{\circ-1} \in \text{Aut}(K(0, 1))$.

(iii) Prove that $\text{Aut}(K(0, 1))$ is given by formula (5).

8.5. Give a proof of the local version of the maximum modulus principle based on Theorem 7.6.

8.6. The set $G = (\mathbb{C} \setminus \{0\}) \times \mathbb{C}$ is equipped with the composition rule

$$(a_1, b_1) * (a_2, b_2) = (a_1 a_2, a_1 b_2 + b_1).$$

Prove that G is a group with the neutral element $(1, 0)$ and that $(a, b)^{-1} = (1/a, -b/a)$. Prove that the mapping $\varphi : G \rightarrow \text{Aut}(\mathbb{C})$ given by $\varphi(a, b)(z) = az + b$ is an isomorphism of groups.

8.7. Prove that the maximum modulus $M_f(r) = \exp(r)$, $r \geq 0$ when $f(z) = \exp(z)$, and that $M_f(r) = \cosh(r)$, $r \geq 0$ when f is one of the two functions \cos, \cosh . Prove also (but this is harder) that $M_f(r) = \sinh(r)$, $r \geq 0$ when f is one of the two functions \sin, \sinh .

§9. Möbius transformations¹⁷

9.1. The Riemann sphere and the extended complex plane.

In section 6.4 we have assigned the value ∞ to a pole of a meromorphic function, i.e. we assume that a meromorphic function takes values in $\mathbb{C} \cup \{\infty\}$. The reason is that when f has a pole at $z = a$, then $f(z) \rightarrow \infty$ for $z \rightarrow a$ in the sense that

$$\forall M > 0 \exists \varepsilon > 0 \forall z \in K'(a, \varepsilon) : |f(z)| \geq M. \quad (1)$$

We call $\mathbb{C}^* = \mathbb{C} \cup \{\infty\}$ the *extended complex plane*. It is possible to equip \mathbb{C}^* with a topology such that the subspace topology on \mathbb{C} is the ordinary topology. We do this by introducing a metric on \mathbb{C}^* called the *chordal metric*, which induces the ordinary topology on \mathbb{C} .

The chordal metric is defined by

$$\chi(z, w) = \begin{cases} \frac{|z-w|}{\sqrt{(1+|z|^2)(1+|w|^2)}}, & z, w \in \mathbb{C} \\ \frac{1}{\sqrt{1+|z|^2}}, & z \in \mathbb{C}, w = \infty \\ 0, & z, w = \infty. \end{cases}$$

To see that χ is a metric we refer to exc. 9.1. Note that for $z, w \in \mathbb{C}$ we have $\chi(z, w) < |z - w|$ unless $z = w$.

Consider a function $f : G \rightarrow \mathbb{C}^*$, where G is an open subset of \mathbb{C} and let $a \in G$. From a metric space point of view $f(z) \rightarrow \infty$ for $z \rightarrow a$ means that

$$\lim_{z \rightarrow a} \chi(\infty, f(z)) = 0,$$

which by definition of the chordal metric is equivalent to

$$\lim_{z \rightarrow a} \frac{1}{\sqrt{1 + |f(z)|^2}} = 0,$$

and this is clearly equivalent to (1). This shows that a meromorphic function $f : G \rightarrow \mathbb{C}^*$ is continuous as a mapping into the metric space (\mathbb{C}^*, χ) .

We will now show how we can visualize \mathbb{C}^* as a sphere called the *Riemann sphere*. Think of \mathbb{C} as the plane Π in \mathbb{R}^3 with coordinates $(x, y, 0)$ and place a ball upon it such that they touch each other at $(0, 0, 0)$ and has $N = (0, 0, 1)$

¹⁷A.F. Möbius (1790-1868), German mathematician and astronomer, also known for the Möbius band.

as its north pole. Here we have used a geographic terminology to support the intuition. The centre of the ball is $C = (0, 0, \frac{1}{2})$ and its radius is $\frac{1}{2}$. The surface of this ball is called the Riemann sphere \mathcal{S} .

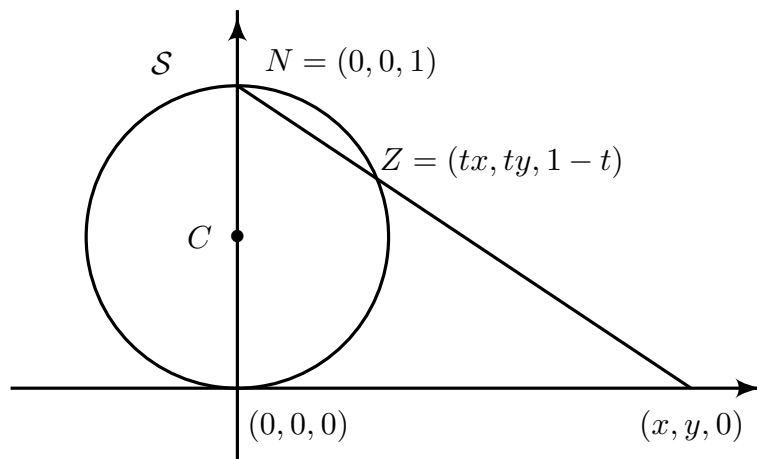

Figure 9.1

A complex number $z = x + iy$ corresponds to the point $(x, y, 0)$ in the plane Π , and the line through this point and the north pole intersects the sphere at the point

$$\Phi(z) = Z = (tx, ty, 1 - t) = (1 - t)(0, 0, 1) + t(x, y, 0),$$

where $0 < t \leq 1$ is determined by the requirement that the euclidean distance from Z to the centre C is $\frac{1}{2}$, i.e.

$$t^2x^2 + t^2y^2 + (\frac{1}{2} - t)^2 = \frac{1}{4},$$

or

$$t = \frac{1}{1 + x^2 + y^2} = \frac{1}{1 + |z|^2},$$

hence

$$\Phi(z) = Z = \left(\frac{x}{1 + x^2 + y^2}, \frac{y}{1 + x^2 + y^2}, \frac{x^2 + y^2}{1 + x^2 + y^2} \right), \quad z = x + iy. \quad (2)$$

To every point $z \in \mathbb{C}$ is thus associated a unique point $\Phi(z) = Z$ on the Riemann sphere given by (2). To the point $z = 0$ is associated the south pole $(0, 0, 0)$. In this way we have a bijection of \mathbb{C} onto the Riemann sphere apart from the north pole N . If $z \in \mathbb{C}$ moves to “infinity” by letting $|z|$ become very big, then the corresponding point Z on the Riemann sphere will approach the north pole. If z moves on the circle $|z| = R$, then Z will move on a circle on the sphere called a parallel (of latitude). When $|z| = 1$,

then $t = \frac{1}{2}$ and Z will move along the equator. For $z, w \in \mathbb{C}$ it is easy to prove that $\chi(z, w)$ is the distance in space (=the length of the chord) between the corresponding points Z, W on the sphere, cf. exc. 9.1. The length of the chord between the north pole N and Z is exactly the number $1/\sqrt{1+|z|^2}$. In symbols

$$\text{dist}(Z, W) = \chi(z, w), \quad z, w \in \mathbb{C}^*, \quad (3)$$

i.e. the mapping $\Phi : \mathbb{C}^* \rightarrow \mathcal{S}$ given by $\Phi(z) = Z, \Phi(\infty) = N$ is an isometry of (\mathbb{C}^*, χ) onto \mathcal{S} equipped with the restriction of the euclidean distance dist in \mathbb{R}^3 . Therefore (\mathbb{C}^*, χ) is a compact metric space. In principle we shall distinguish between the points of \mathbb{C}^* and \mathcal{S} , but in many treatments of the theory the extended complex plane is identified with the Riemann sphere.

The Riemann sphere is an important example of a compact Riemann surface.

The inverse mapping of $\Phi : \mathbb{C} \rightarrow \mathcal{S} \setminus \{N\}$ is denoted σ and is called a *stereographic projection*. From (2) we get that $\sigma : \mathcal{S} \setminus \{N\} \rightarrow \mathbb{C}$ is given by

$$\sigma(\xi, \eta, \zeta) = \frac{\xi}{1-\zeta} + i\frac{\eta}{1-\zeta}, \quad (\xi, \eta, \zeta) \in \mathcal{S} \setminus \{N\}. \quad (4)$$

In fact, for $(\xi, \eta, \zeta) \in \mathcal{S} \setminus \{N\}$ we have $0 \leq \zeta < 1$ so $z = \xi/(1-\zeta) + i\eta/(1-\zeta) \in \mathbb{C}$ is well-defined. The equation of \mathcal{S} can be written $\xi^2 + \eta^2 = \zeta(1-\zeta)$, hence

$$|z|^2 = \frac{\xi^2 + \eta^2}{(1-\zeta)^2} = \frac{\zeta}{1-\zeta}, \quad 1 + |z|^2 = \frac{1}{1-\zeta},$$

and by (2) we finally get that $\Phi(z) = (\xi, \eta, \zeta)$.

Theorem 9.1. *The stereographic projection σ given by (4) maps circles on $\mathcal{S} \setminus \{N\}$ into circles in \mathbb{C} and circles on \mathcal{S} passing through N into lines in \mathbb{C} .*

Proof. A circle on \mathcal{S} is the intersection between \mathcal{S} and a plane Σ . If the circle and hence the plane contains N , then its image under σ is the intersection of the planes Σ and Π , hence a line in \mathbb{C} .

Assume next that the plane Σ does not contain N . The equation of a plane Σ in \mathbb{R}^3 is the set of $(\xi, \eta, \zeta) \in \mathbb{R}^3$ satisfying $a\xi + b\eta + c\zeta = d$, where (a, b, c) is a unit vector in \mathbb{R}^3 , a unit normal vector to Σ . Since $N = (0, 0, 1) \notin \Sigma$ we have $c \neq d$. Using that $(\xi, \eta, \zeta) = \Phi(z)$ for $z \in \mathbb{C}$, we get by (2) that the points $z = x + iy$ of $\sigma(\mathcal{S} \cap \Sigma)$ satisfy

$$a\frac{x}{1+|z|^2} + b\frac{y}{1+|z|^2} + c\frac{|z|^2}{1+|z|^2} = d,$$

hence $(c-d)|z|^2 + ax + by = d$, which for $c \neq d$ is the equation of a circle in \mathbb{C} . \square

Remark 9.2 It can also be proved that the stereographic projection σ is angle preserving in the following sense: *Curves on $\mathcal{S} \setminus \{N\}$ intersecting each other under an angle α are mapped to curves in \mathbb{C} intersecting each other under the same angle.* See Hille, Vol. I p. 41.

9.2. Möbius transformations.

The set of regular 2×2 -matrices having complex entries is denoted $GL_2(\mathbb{C})$. To $G \in GL_2(\mathbb{C})$ we consider the expression

$$f(z) = M(G)(z) = \frac{az + b}{cz + d}, \quad G = \begin{pmatrix} a & b \\ c & d \end{pmatrix}. \quad (1)$$

(Regularity of G just means that $\det G = ad - bc \neq 0$.) Functions of this type are called *Möbius transformations* or *linear fractional transformations*.

Let us consider some examples.

$$1) \quad G = \begin{pmatrix} a & 0 \\ 0 & 1 \end{pmatrix}, \quad a \neq 0.$$

The function is $f(z) = az$. The action of f is a *homothetic transformation* or a *similitude* with factor $|a|$ followed by a *rotation* of size (angle) $\arg(a)$. The homothetic transformation is called a *stretching* if $|a| > 1$, and a *contraction* if $|a| < 1$. If $|a| = 1$ the action is a pure rotation. In all cases a figure is mapped to a figure of the same shape.

$$2) \quad G = \begin{pmatrix} 1 & b \\ 0 & 1 \end{pmatrix}, \quad b \in \mathbb{C}.$$

The function is $f(z) = z + b$. The action of f is a *translation* by the vector b . Also in this case a figure is mapped onto a figure of the same shape.

In both cases we have $\lim_{z \rightarrow \infty} f(z) = \infty$, and defining $f(\infty) = \infty$ we obtain that f is a bijection of \mathbb{C}^* onto itself and it is continuous on \mathbb{C}^* . The inverse mapping has the same form as f , namely $f^{\circ-1}(z) = (1/a)z$ in the first case and $f^{\circ-1}(z) = z - b$ in the second.

Therefore, in both cases f is a homeomorphism¹⁸ of \mathbb{C}^* onto itself.

$$3) \quad G = \begin{pmatrix} 0 & 1 \\ 1 & 0 \end{pmatrix}.$$

The function is $f(z) = 1/z$. In this case f is a bijection of $\mathbb{C} \setminus \{0\}$, and it is its own inverse and is continuous. Since

$$\lim_{z \rightarrow 0} f(z) = \infty, \quad \lim_{z \rightarrow \infty} f(z) = 0,$$

it is reasonable to define $f(0) = \infty, f(\infty) = 0$, hence f is a bijection of \mathbb{C}^* . It is its own inverse and a homeomorphism.

¹⁸It is recalled that a mapping $f : X \rightarrow Y$ between topological spaces is called a *homeomorphism* if f is a bijection and f as well as its inverse $f^{\circ-1}$ are continuous.

The action of f is an *inversion* in the unit circle $re^{it} \rightarrow (1/r)e^{it}$ followed by a *reflection* in the real axis $z \rightarrow \bar{z}$.

By the inversion in the unit circle all points of the circle are fixed, and each open half-line emanating from zero is mapped onto itself in such a way that points inside the unit circle are mapped to points outside the unit circle and vice versa.

We shall now see that the expression (1) defines a homeomorphism of \mathbb{C}^* , and that it can be written as the composition of mappings of the type 1)-3). Notice that we assume $ad - bc \neq 0$.

If $c = 0$ then $a, d \neq 0$ and hence $f(z) = (a/d)z + (b/d)$, which is a composition of mappings of type 1) and 2), hence a homeomorphism of \mathbb{C}^* .

If $c \neq 0$ we find

$$f(z) = \frac{(a/c)(cz + d) + b - ad/c}{cz + d} = \frac{a}{c} + \frac{\lambda}{cz + d}, \quad \lambda = -\frac{ad - bc}{c},$$

which shows that f is equal to the composition of $z \rightarrow cz + d$, $z \rightarrow 1/z$ and $z \rightarrow \lambda z + a/c$, hence f is a homeomorphism of \mathbb{C}^* .

Summing up we have proved:

Theorem 9.3. *The Möbius transformation (1) associated with the regular matrix G is a homeomorphism of \mathbb{C}^* and the inverse mapping $f^{\circ-1}$ is again a Möbius transformation since*

$$f(z) = \frac{az + b}{cz + d} = w \iff f^{\circ-1}(w) = \frac{dw - b}{-cw + a} = z. \quad (2)$$

We have $f(\infty) = a/c$, $f(-d/c) = \infty$ with the convention that the relevant fractions shall be understood as ∞ , if the denominator $c = 0$.

Let $\text{Homeo}(\mathbb{C}^*)$ denote the set of homeomorphisms of \mathbb{C}^* . This set is a group under composition of mappings, the neutral element being the identity mapping I of \mathbb{C}^* .

Theorem 9.4. *A Möbius transformation (1), which is not the identity of \mathbb{C}^* , has one or two fixed points in \mathbb{C}^* .*

Proof. The Möbius transformation (1) has $z = \infty$ as a fixed point if and only if $c = 0$.

Assume first $c = 0$. Then $f(z) = (a/d)z + b/d$ and if $a \neq d$ then f has the additional fixed point $z = b/(d - a)$. If $a = d$ there are two possibilities: If $b = 0$ then f is the identity, and if $b \neq 0$ then f is a true translation $f(z) = z + b/d$ with no fixed points other than $z = \infty$.

Assume next $c \neq 0$. Then $z \in \mathbb{C}$ is a fixed point if and only if

$$cz^2 + (d - a)z - b = 0,$$

which has one or two solutions. □

Theorem 9.5. *The mapping $M : GL_2(\mathbb{C}) \rightarrow \text{Homeo}(\mathbb{C}^*)$ defined by (1) is a group homomorphism such that*

$$\ker(M) := \{G \in GL_2(\mathbb{C}) \mid M(G) = I\} = \left\{ \begin{pmatrix} \lambda & 0 \\ 0 & \lambda \end{pmatrix} \mid \lambda \in \mathbb{C} \setminus \{0\} \right\}.$$

Proof. For

$$G = \begin{pmatrix} a & b \\ c & d \end{pmatrix}, H = \begin{pmatrix} \alpha & \beta \\ \gamma & \delta \end{pmatrix} \in GL_2(\mathbb{C})$$

we have

$$GH = \begin{pmatrix} a\alpha + b\gamma & a\beta + b\delta \\ c\alpha + d\gamma & c\beta + d\delta \end{pmatrix},$$

hence

$$M(GH)(z) = \frac{(a\alpha + b\gamma)z + a\beta + b\delta}{(c\alpha + d\gamma)z + c\beta + d\delta},$$

while

$$M(G) \circ M(H)(z) = \frac{a \frac{\alpha z + \beta}{\gamma z + \delta} + b}{c \frac{\alpha z + \beta}{\gamma z + \delta} + d} = \frac{a(\alpha z + \beta) + b(\gamma z + \delta)}{c(\alpha z + \beta) + d(\gamma z + \delta)},$$

which shows that $M(GH)(z) = M(G) \circ M(H)(z)$, i.e. M is a homomorphism of groups.

If $M(G) = I$ we have

$$\frac{az + b}{cz + d} = z \text{ for all } z \in \mathbb{C}, \quad (3)$$

hence $cz^2 + (d-a)z - b = 0$ for all $z \in \mathbb{C}$, but this is only possible if $b = c = 0$ and $a = d$. On the other hand it is clear that all the diagonal matrices

$$G = \begin{pmatrix} \lambda & 0 \\ 0 & \lambda \end{pmatrix}$$

with $\lambda \neq 0$ belong to $GL_2(\mathbb{C})$ and satisfy $M(G) = I$.

A matrix $G \in GL_2(\mathbb{C})$ and all its non-zero multiples λG , $\lambda \neq 0$ determine the same Möbius transformation. The theorem tells that if $H \in GL_2(\mathbb{C})$ determines the same Möbius transformation as G , then $HG^{-1} \in \ker(M)$ because M is a homomorphism, and hence $H = \lambda G$ for some $\lambda \neq 0$. \square

In Theorem 9.1 we have proved that circles on the Riemann sphere are mapped to either circles or lines in \mathbb{C} under the stereographic projection.

This makes it convenient to introduce the following terminology:

Definition 9.6. A *generalized circle* Γ in \mathbb{C}^* is either a circle in \mathbb{C} or a line augmented by ∞ . We may consider a line as a circle through the point ∞ .

With this definition we have:

Theorem 9.7. *Every Möbius transformation maps a generalized circle onto a generalized circle.*

Proof. Using that every Möbius transformation can be composed of Möbius transformations of the three types 1)-3) above, it suffices to prove the result for each of these types. The assertion being clear for the two first types, which in fact maps lines onto lines, circles onto circles, and leaves ∞ fixed, it suffices to prove it for the Möbius transformation $f(z) = 1/z$.

The equation of the circle $\partial K(-a, r)$ can be written

$$|z + a|^2 = r^2, \quad a \in \mathbb{C}, r > 0,$$

hence

$$|z|^2 + \bar{a}z + a\bar{z} + |a|^2 - r^2 = 0, \quad (4)$$

and the equation of a line can be written

$$\alpha x + \beta y + \gamma = 0, \quad \alpha, \beta, \gamma \in \mathbb{R}, (\alpha, \beta) \neq (0, 0),$$

or if we put $a = (\alpha + i\beta)/2 \in \mathbb{C} \setminus \{0\}$

$$\bar{a}z + a\bar{z} + \gamma = 0. \quad (5)$$

The equation for a generalized circle in \mathbb{C} can therefore be written

$$\delta|z|^2 + \bar{a}z + a\bar{z} + \gamma = 0, \quad \delta, \gamma \in \mathbb{R}, a \in \mathbb{C}, \quad (6)$$

with the assumption $|a|^2 > \gamma\delta$. The case (4) corresponds to $\delta = 1, \gamma = |a|^2 - r^2$, hence $|a|^2 > \gamma\delta$. The case (5) corresponds to $\delta = 0$, so $|a|^2 > \gamma\delta$ also holds in this case.

Conversely, the equation (6) with $\delta = 0$ gives (5), while (6) with $\delta \neq 0$ gives

$$|z|^2 + \frac{\bar{a}}{\delta}z + \frac{a}{\delta}\bar{z} + \frac{\gamma}{\delta} = 0,$$

or

$$\left|z + \frac{a}{\delta}\right|^2 = \frac{|a|^2 - \gamma\delta}{\delta^2},$$

which describes a circle when $|a|^2 > \gamma\delta$. The image of the generalized circle (6) under $z \rightarrow 1/z$ is determined in the following way: Dividing (6) by $z\bar{z}$ gives

$$\delta + \frac{\bar{a}}{\bar{z}} + \frac{a}{z} + \frac{\gamma}{z\bar{z}} = 0$$

or with $w = 1/z$

$$\gamma|w|^2 + aw + \bar{a}\bar{w} + \delta = 0, \quad (7)$$

showing that w satisfies the equation of a generalized circle.

If $z = 0$ belongs to the generalized circle (6) we have $\gamma = 0$, and then (7) is the equation of a line. This corresponds to the fact that a generalized circle through 0 is mapped into a line under $z \rightarrow 1/z$, a line being a generalized circle through infinity. \square

The following result is easy:

Given 3 different points $z_1, z_2, z_3 \in \mathbb{C}^$ there exists a uniquely determined generalized circle Γ such that $z_1, z_2, z_3 \in \Gamma$.*

If one of the 3 points is ∞ then Γ is clearly a line through the two finite points. If $z_1, z_2, z_3 \in \mathbb{C}$ then Γ is either a line or a circle. The case of a circle occurs if z_1, z_2, z_3 are the vertices of a non-degenerate triangle, and Γ is its circumscribed circle.

Theorem 9.8. *Let $(z_1, z_2, z_3), (w_1, w_2, w_3)$ be two ordered triples of different points in \mathbb{C}^* . Then there exists one and only one Möbius transformation $f: \mathbb{C}^* \rightarrow \mathbb{C}^*$ such that $f(z_j) = w_j, j = 1, 2, 3$.*

Proof. Assume first that $w_1 = 0, w_2 = 1, w_3 = \infty$.

If $z_1, z_2, z_3 \in \mathbb{C}$, then f defined by

$$f(z) = \frac{(z_2 - z_3)(z - z_1)}{(z_2 - z_1)(z - z_3)} \quad (8)$$

is a Möbius transformation with the desired properties. On the other hand, if a Möbius transformation f satisfies $f(z_1) = 0$, then the numerator must be $k(z - z_1)$, and if $f(z_3) = \infty$ the denominator must be $l(z - z_3)$. Finally, if $f(z_2) = 1$ we get

$$f(z_2) = 1 = \frac{k(z_2 - z_1)}{l(z_2 - z_3)},$$

so f is given by (8).

If $z_1 = \infty, z_2, z_3 \in \mathbb{C}$, then

$$f(z) = \frac{z_2 - z_3}{z - z_3}$$

is a Möbius transformation mapping (∞, z_2, z_3) onto $(0, 1, \infty)$. It is also easy to see that this is the only possibility for f .

Similarly, if $z_1, z_3 \in \mathbb{C}, z_2 = \infty$ (resp. $z_1, z_2 \in \mathbb{C}, z_3 = \infty$), then

$$f(z) = \frac{z - z_1}{z - z_3} \quad \left(\text{resp. } f(z) = \frac{z - z_1}{z_2 - z_1} \right)$$

are the only Möbius transformations with the desired properties.

Assume next that w_1, w_2, w_3 are arbitrary different points in \mathbb{C}^ .*

Let f, g be the Möbius transformations such that f maps (z_1, z_2, z_3) onto $(0, 1, \infty)$ and g maps (w_1, w_2, w_3) onto $(0, 1, \infty)$. Then the composed Möbius transformation $g^{\circ-1} \circ f$ maps (z_1, z_2, z_3) onto (w_1, w_2, w_3) .

Finally, if f, g both map (z_1, z_2, z_3) onto (w_1, w_2, w_3) , then $g^{\circ-1} \circ f$ has 3 fixed points z_1, z_2, z_3 . By Theorem 9.4 we then get $g^{\circ-1} \circ f = I$, hence $f = g$. \square

Example 9.9. The Cayley transformation. The Möbius transformation

$$C(z) = \frac{z - i}{z + i}$$

is called the Cayley transformation.

C maps $\mathbb{R} \cup \{\infty\}$ onto the unit circle $\{z \in \mathbb{C} \mid |z| = 1\}$, the upper half-plane \mathbb{U} onto the unit disc $\mathbb{D} = \{z \in \mathbb{C} \mid |z| < 1\}$ and the lower half-plane \mathbb{L} onto the exterior of the unit circle augmented by ∞ .

To see this we calculate $C(0) = -1, C(1) = -i, C(\infty) = 1$, so the generalized circle determined by $0, 1, \infty$ (=the real line) is mapped onto the generalized circle determined by $-1, -i, 1$ (=the unit circle). Since C is a bijection of \mathbb{C}^* , $\mathbb{U} \cup \mathbb{L}$ must be mapped onto the complement of the unit circle in \mathbb{C}^* , which consists of the interior and the exterior of the unit circle and the point ∞ . Note that $C(-i) = \infty$. We also know that $C(\mathbb{U})$ and $C(\mathbb{L} \setminus \{-i\})$ are domains in \mathbb{C} by the open mapping theorem, and therefore $C(\mathbb{U})$ has to be either the interior or the exterior of the unit circle. In fact, if it contained a point A from the interior and a point B from the exterior of the unit circle it cannot be path connected, since a path from A to B would cross the unit circle. Similarly $C(\mathbb{L} \setminus \{-i\})$ has to be either the interior or the exterior of the unit circle. Since $C(i) = 0$ we conclude that $C(\mathbb{U}) = \mathbb{D}$. We can also argue that since $C(-i) = \infty$, then $C(\mathbb{L} \setminus \{-i\})$ is an unbounded set, hence the exterior of the unit circle.

Since C maps $(i, 0, -i)$ onto $(0, -1, \infty)$ the imaginary axis is mapped to the real axis. More precisely

$$C(i\mathbb{R}) = (\mathbb{R} \setminus \{1\}) \cup \{\infty\}.$$

Notice also that the real and imaginary axis intersect each other at 0 under the angle $\pi/2$, and since $C'(0) = -2i$ the image curves intersect each other at -1 under the same angle by the results of section 1.2. In this case the image curves are the unit circle and the real axis and they intersect at -1 under the angle $\pi/2$. (The real and imaginary axis also intersect each other at infinity which corresponds to the intersection of the unit circle and the real axis at 1. The two lines intersect at infinity under the angle $\pi/2$ if we look at the corresponding circles on the Riemann sphere. They intersect each other at the north pole under the angle $\pi/2$.)

Exercises for §9

9.1. The Riemann sphere \mathcal{S} is defined as the sphere

$$\{(\xi, \eta, \zeta) \in \mathbb{R}^3 \mid \xi^2 + \eta^2 + (\zeta - \frac{1}{2})^2 = \frac{1}{4}\}.$$

To $z = x + iy \in \mathbb{C}$ is associated the point $Z \in \mathcal{S}$ given by

$$\Phi(z) = Z = (tx, ty, 1 - t), \quad t = \frac{1}{1 + x^2 + y^2},$$

which is the intersection between \mathcal{S} and the segment from $N = (0, 0, 1)$ to $(x, y, 0)$.

Prove that if $w = u + iv \in \mathbb{C}$ is another point corresponding to $W \in \mathcal{S}$ such that

$$\Phi(w) = W = (su, sv, 1 - s), \quad s = \frac{1}{1 + u^2 + v^2},$$

then the euclidean distance $\text{dist}(Z, W)$ is equal to the chordal distance $\chi(z, w)$ from section 9.1. Prove also that

$$\text{dist}(N, Z) = \frac{1}{\sqrt{1 + x^2 + y^2}}, \quad z \in \mathbb{C}, N = (0, 0, 1).$$

Use this to prove that χ is a metric on \mathbb{C}^* and that the mapping $\Phi : \mathbb{C}^* \rightarrow \mathcal{S}$ given by $\Phi(z) = Z, \Phi(\infty) = N$ is an isometry between metric spaces.

Explain why the spaces (\mathbb{C}^*, χ) and $(\mathcal{S}, \text{dist})$ are compact.

9.2. Prove that the Möbius transformation

$$f(z) = \frac{az + b}{cz + d}, \quad G = \begin{pmatrix} a & b \\ c & d \end{pmatrix} \in GL_2(\mathbb{C})$$

satisfies

$$f'(z) = \frac{\det G}{(cz + d)^2}, \quad z \in \mathbb{C} \setminus \{-\frac{d}{c}\},$$

so f is conformal at all points of $\mathbb{C} \setminus \{-d/c\}$, cf. Section 1.2.

9.3. Find the determinant of $G \in GL_2(\mathbb{C})$ defining the Möbius transformation (8) in Section 9.2.

9.4. Consider the Möbius transformation $f(z) = (1 + z)/(1 - z)$ and prove that it maps the imaginary axis to the unit circle, the unit circle to the extended imaginary axis, and the extended real axis to itself.

Find the image of the domains

$$\{z \in \mathbb{C} \mid |z| < 1\}, \quad \{z \in \mathbb{C} \mid |z| > 1\}$$

$$\{z \in \mathbb{C} \mid |z| < 1, \operatorname{Re} z > 0\}, \quad \{z \in \mathbb{C} \mid |z| < 1, \operatorname{Re} z < 0\}.$$

Show that the vertical line $\operatorname{Re} z = -1$ is mapped to the circle $\partial K(-\frac{1}{2}, \frac{1}{2})$ and that the vertical strip $\{z \in \mathbb{C} \mid -1 < \operatorname{Re} z < 0\}$ is mapped onto $K(0, 1) \setminus \overline{K(-\frac{1}{2}, \frac{1}{2})}$.

9.5. Using the theory of Möbius transformations show that the transformations f_{z_0} given in (4) of Section 8 maps the unit circle onto itself and also the unit disc onto itself. Show that the points

$$z_0, \quad \frac{1+z_0}{1+\overline{z_0}}, \quad \frac{1}{\overline{z_0}} \tag{1}$$

are mapped to $0, 1, \infty$. Prove that the generalized circle determined by (1) intersects the unit circle under an angle of $\pi/2$.

9.6. Let $SL_2(\mathbb{R})$ denote the set of 2×2 matrices of real numbers with determinant 1. Prove that the Möbius transformation $f = M(G)$ given by a matrix $G \in SL_2(\mathbb{R})$ maps the upper half-plane onto itself.

9.7. Determine the fixed points of the Cayley transformation.

§A. Appendix

Various topological results

Lemma A.1. *Let $K, F \subseteq \mathbb{C}$ be two non-empty closed and disjoint sets, and assume in addition that K is bounded. Then the distance $d(K, F)$ between K and F defined by*

$$d(K, F) = \inf\{|z - w| \mid z \in K, w \in F\}$$

satisfies $d(K, F) > 0$, and there exist points $z' \in K$, $w' \in F$ such that $|z' - w'| = d(K, F)$.

Proof. For any $n \in \mathbb{N}$ we can choose $z_n \in K$, $w_n \in F$ satisfying

$$d(K, F) \leq |z_n - w_n| < d(K, F) + \frac{1}{n}. \quad (1)$$

Since K is bounded there exists $R > 0$ such that $|z| \leq R$ for all $z \in K$. We claim that also the sequence (w_n) is bounded, because

$$|w_n| = |w_n - z_n + z_n| \leq |w_n - z_n| + |z_n| < d(K, F) + \frac{1}{n} + R \leq d(K, F) + 1 + R.$$

Since (z_n) as well as (w_n) are bounded, the sequence $(z_n, w_n) \in \mathbb{C}^2 \approx \mathbb{R}^4$ has a convergent subsequence (z_{n_p}, w_{n_p}) with limit $(z', w') \in \mathbb{C}^2$. By assumption K and F are closed, hence $z' \in K$, $w' \in F$, and using the continuity of $(z, w) \mapsto |z - w|$ from $\mathbb{C}^2 \rightarrow \mathbb{R}$, we get

$$|z_{n_p} - w_{n_p}| \rightarrow |z' - w'|,$$

which together with (1) gives

$$d(K, F) = |z' - w'|.$$

This number has to be > 0 , for otherwise $z' = w'$, which is then a point in $K \cap F$, contradicting the assumption $K \cap F = \emptyset$. \square

Remark A.2. Two closed and unbounded disjoint subsets of \mathbb{C} can have the distance 0. A simple example is $F_1 = \mathbb{R}$, $F_2 = \{x + \frac{i}{x} \mid x > 0\}$, i.e. a branch of the hyperbola with the x-axis as an asymptote.

Theorem A.3. *Let $A \subseteq \mathbb{R}^k$ be closed and bounded and let $f : A \rightarrow \mathbb{R}^l$ be continuous. Then the image $f(A)$ is closed and bounded in \mathbb{R}^l . In particular for $l = 1$ the function f has a minimum and a maximum, i.e. there exist points $a_1, a_2 \in A$ such that*

$$f(a_1) = \inf f(A), \quad f(a_2) = \sup f(A).$$

Proof. In order to see that $f(A)$ is closed, we consider a sequence $x^{(n)}$ from A such that $f(x^{(n)}) \rightarrow b$. We shall prove that $b \in f(A)$. By Bolzano-Weierstrass's theorem there exist $a \in A$ and a subsequence $x^{(n_p)}$ of $x^{(n)}$ such that $x^{(n_p)} \rightarrow a$. Using that f is continuous, we see that $f(x^{(n_p)}) \rightarrow f(a)$. However, every subsequence of $f(x^{(n)})$ tends to b , hence $f(a) = b$, i.e. $b \in f(A)$.

Assume next that $f(A)$ is unbounded. For every $n \in \mathbb{N}$ we can then find $x^{(n)} \in A$ such that $\|f(x^{(n)})\| \geq n$. As before there exists $a \in A$ and a subsequence $x^{(n_p)}$ such that $x^{(n_p)} \rightarrow a$, hence $f(x^{(n_p)}) \rightarrow f(a)$ because of the continuity of f . By continuity of $\|\cdot\|$ we then get $\|f(x^{(n_p)})\| \rightarrow \|f(a)\|$, but this contradicts $\|f(x^{(n_p)})\| \geq n_p \rightarrow \infty$.

In the special case $l = 1$ we have that $f(A)$ is a closed and bounded subset of \mathbb{R} , hence $\inf f(A), \sup f(A) \in f(A)$. \square

For a closed non-empty subset F of \mathbb{C} we define $d_F : \mathbb{C} \rightarrow [0, \infty[$ by

$$d_F(z) = \inf\{|z - a| \mid a \in F\}, \quad (2)$$

called the distance from z to F .

Theorem A.4. *The distance is a continuous function $d_F : \mathbb{C} \rightarrow [0, \infty[$ satisfying*

$$\forall z \in \mathbb{C} : d_F(z) = 0 \iff z \in F.$$

Proof. For $z \in F$ we clearly have $d_F(z) \leq |z - z| = 0$. For $z \notin F$ it follows by Lemma A.1 that $d_F(z) = d(\{z\}, F) > 0$.

For $z_1, z_2 \in \mathbb{C}$, $a \in F$ we get by the triangle inequality

$$d_F(z_1) \leq |z_1 - a| \leq |z_1 - z_2| + |z_2 - a|,$$

showing that $d_F(z_1) - |z_1 - z_2|$ is a lower bound for the numbers $|z_2 - a|$, $a \in F$. By the definition of infimum we then get

$$d_F(z_1) - |z_1 - z_2| \leq d_F(z_2)$$

or

$$d_F(z_1) - d_F(z_2) \leq |z_1 - z_2|.$$

Interchanging z_1 and z_2 , we finally get

$$|d_F(z_1) - d_F(z_2)| \leq |z_1 - z_2|,$$

which proves that d_F is continuous (even diminishing distances). \square

Theorem A.5. *To every open set $G \subseteq \mathbb{C}$ there exists an increasing sequence $K_1 \subseteq K_2 \subseteq \dots$ of closed and bounded subsets of G such that their union is G .*

Proof. If $G = \mathbb{C}$ we can define $K_n = \{z \in \mathbb{C} \mid |z| \leq n\}$. If $G \neq \mathbb{C}$ we consider the distance function $d = d_{\mathbb{C} \setminus G}$, cf. (2) with $F = \mathbb{C} \setminus G$, and define

$$F_n = \left\{ z \in \mathbb{C} \mid d(z) \geq \frac{1}{n} \right\} = d^{-1} \left(\left[\frac{1}{n}, \infty \right) \right).$$

The continuity of d implies that F_n is closed, and since $d(z) > 0$ for $z \in G$ we have $F_n \subseteq G$. The sets

$$K_n = F_n \cap \{z \in \mathbb{C} \mid |z| \leq n\}$$

form an increasing sequence of closed and bounded subsets of G . Any $z \in G$ belongs to K_n for n sufficiently big because $d(z) > 0$. \square

Theorem A.6. *Let $A \subseteq \mathbb{C}$ be path connected and assume that $f : A \rightarrow \mathbb{C}$ is continuous. Then the image set $f(A)$ is path connected.*

Proof. Two arbitrary points in $f(A)$ can be written $f(P), f(Q)$, where $P, Q \in A$. Let $\gamma : [0, 1] \rightarrow A$ denote a continuous curve in A from P to Q . Then the composed function $f \circ \gamma$ is a continuous curve in $f(A)$ from $f(P)$ to $f(Q)$. \square

Theorem A.7. *Let $A \subseteq \mathbb{R}^k$ and let $B \subseteq \mathbb{R}^l$ be closed and bounded. If $f : A \times B \rightarrow \mathbb{C}$ is a continuous function, then for any $x_0 \in A$*

$$\lim_{x \rightarrow x_0} f(x, y) = f(x_0, y), \text{ uniformly for } y \in B,$$

i.e.

$$\forall \varepsilon > 0 \exists \delta > 0 \forall x \in A : \|x - x_0\| < \delta \Rightarrow \forall y \in B : |f(x, y) - f(x_0, y)| < \varepsilon.$$

Proof. Given $\varepsilon > 0$ and a point $(x_0, y_0) \in A \times B$, the continuity of f at (x_0, y_0) implies that there exist $\delta(x_0, y_0) > 0, r(x_0, y_0) > 0$ such that for $(x, y) \in A \times B$

$$\|x - x_0\| < \delta(x_0, y_0), \|y - y_0\| < r(x_0, y_0) \Rightarrow |f(x, y) - f(x_0, y_0)| < \varepsilon/2.$$

The family of open balls $\{K(y_0, r(x_0, y_0)) \mid y_0 \in B\}$ cover B , so by Borel's covering Theorem 4.13 there exist finitely many points $y_1, y_2, \dots, y_n \in B$ such that

$$B \subseteq \cup_{j=1}^n K(y_j, r(x_0, y_j)).$$

Define $\delta(x_0) = \min\{\delta(x_0, y_j) \mid j = 1, \dots, n\}$ and notice that $\delta(x_0) > 0$. For $x \in A$ such that $\|x - x_0\| < \delta(x_0)$ and for arbitrary $y \in B$ we claim that

$$|f(x, y) - f(x_0, y)| < \varepsilon. \quad (3)$$

In fact, $y \in K(y_j, r(x_0, y_j))$ for some $j = 1, \dots, n$ because the balls cover B , and using $\|x - x_0\| < \delta(x_0) \leq \delta(x_0, y_j)$ we find

$$|f(x, y) - f(x_0, y_j)| < \varepsilon/2, \quad |f(x_0, y) - f(x_0, y_j)| < \varepsilon/2,$$

and (3) follows by the triangle inequality. \square

Remark A.8. In A.1, A.2, A.4, A.5, A.6 we can replace \mathbb{C} by \mathbb{R}^k for any k .

Countable and uncountable sets

Definition A.9. A set M is called *countable*, if there exists an injective mapping $f : M \rightarrow \mathbb{N}$.

A set is called *uncountable*, if it is not countable.

In order for M to be countable we have to be able to assign a natural number to each element of M in such a way that different elements of M are assigned different numbers, like cloak-room tickets. This is what we are doing when we count the elements in a finite set, so finite sets are countable. The set \mathbb{N} , the set of even numbers and the set of square numbers are infinite countable sets.

Theorem A.10. *The sets \mathbb{Z}, \mathbb{Q} are countable and $[0, 1]$ ¹⁹ is uncountable.*

Proof. Writing $\mathbb{Z} = \{0, 1, -1, 2, -2, \dots\}$, i.e. having placed the elements of \mathbb{Z} in a sequence such that each element appears once and only once, we see that it is countable. A concrete injective mapping $f : \mathbb{Z} \rightarrow \mathbb{N}$, corresponding to this way of writing the set, can be defined by $f(0) = 1, f(n) = 2n$ for $n = 1, 2, \dots, f(n) = 2|n| + 1$ for $n = -1, -2, \dots$.

We only prove that \mathbb{Q}_+ is countable, and the reader is asked to use this to prove that \mathbb{Q} is countable. The following scheme contains all positive rational numbers, in fact they are all repeated infinitely many times.

¹⁹The same is true for every interval consisting of more than one point.

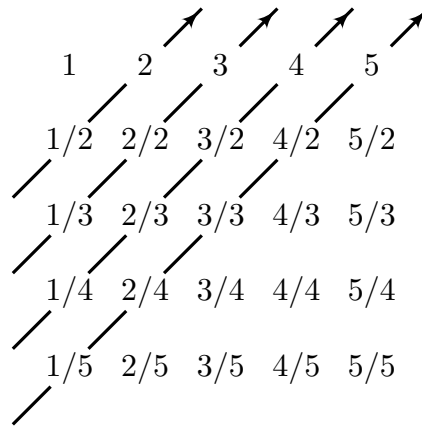

The injective mapping $f : \mathbb{Q}_+ \rightarrow \mathbb{N}$ is now defined in the following way. We count diagonally by following the arrows, but if the number has already been counted, then it is skipped. We then have

$$f(1) = 1, f\left(\frac{1}{2}\right) = 2, f(2) = 3, f\left(\frac{1}{3}\right) = 4, f(3) = 5, f\left(\frac{1}{4}\right) = 6,$$

$$f\left(\frac{2}{3}\right) = 7, f\left(\frac{3}{2}\right) = 8, f(4) = 9, f\left(\frac{1}{5}\right) = 10, f(5) = 11, \dots$$

We now reproduce the ingenious proof of Cantor for the result that $[0, 1]$ is uncountable. Every number in $[0, 1]$ can be written as an infinite decimal fraction $0, a_1 a_2 \dots$, where $a_1, a_2 \dots \in \{0, 1, 2, \dots, 9\}$. If $[0, 1]$ was countable, we could arrange the numbers from $[0, 1]$ in a list, i.e. as a sequence of infinite decimal fractions

$$\begin{aligned} &0, a_{11} a_{12} a_{13} \dots \\ &0, a_{21} a_{22} a_{23} \dots \\ &0, a_{31} a_{32} a_{33} \dots \\ &\dots \end{aligned}$$

It is however easy to produce an infinite decimal fraction giving a number in $[0, 1]$ and which does not belong to the sequence, namely $b = 0, b_1 b_2 \dots$, where for each n the number b_n is chosen among the digits $\{0, 1, 2, \dots, 9\}$ such that $|b_n - a_{nn}| \geq 2$. This procedure ensures that b is different from the n 'th number in the list for each n . (Note that e.g. $0, 0100 \dots = 0, 0099 \dots$, so we have to assume that the digits differ by 2 as above.) \square

Theorem A.11. *Let A_1, A_2, \dots be a sequence of countable sets. Then $M = \cup_1^\infty A_n$ is countable.*

The theorem is proved by exploiting the same idea of proof which was used in establishing that \mathbb{Q}_+ is countable.

Bibliography

There exists a large number of elementary books on complex function theory because the subject is taught at all universities and engineering schools. In addition there are many research monographs treating selected topics from complex analysis.

The present list is only a small selection in addition to the 3 books mentioned in the introduction.

Ablowitz, M.J.; Fokas, A.S.: *Complex Variables. Introduction and Applications*, 2003.

Ahlfors, Lars V.: *Complex Analysis: an Introduction to the theory of Analytic Functions of one Complex Variable*, 1979.

Bak, Joseph; Newman, Donald: *Complex analysis*, 1997.

Berenstein, Carlos A.; Gay, Roger: *Complex variables. An introduction*, 1991.

Churchill, Ruel V.; Brown, James W.; Verhey, Roger, F.: *Complex variables and applications*, 1974.

Conway, John B.: *Functions of one complex variable*, 1973.

Conway, John B.: *Functions of one complex variable II*, 1995.

Forster, Otto: *Lectures on Riemann surfaces*, 1981.

Hayman, W.K.: *Multivalent functions*, 1958.

Jameson, G.J.O.: *A first course on complex functions*, 1970.

Kodaira, Kunihiko: *Introduction to complex analysis*, 1984.

Lang, Serge: *Complex analysis*, 1999.

Littlewood, J.E.: *Lectures on the theory of functions*, 1944.

Marsden, Jerrold E.: *Basic complex analysis*, 1973.

Narasimhan, Raghavan: *Complex analysis in one variable*, 1985.

Remmert, Reinhold: *Classical topics in complex function theory*, 1998.

Stewart, Ian; Tall, David: *Complex Analysis*, 1983.

LIST OF SYMBOLS

$\mathbb{N} = \{1, 2, 3, \dots\}$ The natural numbers
 $\mathbb{N}_0 = \{0, 1, 2, 3, \dots\}$ The natural numbers and 0
 $\mathbb{Z} = \{0, \pm 1, \pm 2, \dots\}$ The integers
 \mathbb{Q} The rational numbers
 \mathbb{R} The real numbers
 \mathbb{C} The complex numbers i.1
 \arg The argument 5.5
 Arg The principal argument 5.5
 Arg_α 5.5
 argvar Variation of argument 5.8
 $\text{Aut}(G)$ Automorphism group of G 8.4
 \mathbb{C}^* Extended complex plane 9.1
 $\mathbb{C}[z]$ Polynomials 4.17
 $\mathbb{C}(z)$ Rational functions 6.8
 $\chi(z, w)$; The chordal metric; 9.1
 f_e 6.17
 f_i 6.17
 $GL_2(\mathbb{C})$ 9.4
 $\mathcal{H}(G)$ Holomorphic functions in G 1.1
 $\text{Homeo}(\mathbb{C}^*)$ 9.5
 $K(a, r)$ Open disc or ball i.1
 $K'(a, r)$ i.1
 $L(\gamma)$ Length of path 2.6
 \ln ; The natural logarithm
 \log Multi-valued logarithm 5.11
 Log Principal logarithm 5.11
 Log_α 5.12
 $\mathcal{M}(G)$ Meromorphic functions in G 6.11
 $M(G)$; Möbius transformation associated to G 9.4
 $\int_\gamma, \int_\gamma f$ 2.4
 $M_f(r)$; The maximum modulus 8.2
 $\omega(\gamma, 0)$; The winding number around 0 5.8, 5.17
 $\omega(\gamma, z)$; The winding number around z 5.20
 $\text{ord}(f, a)$ Order of zero 6.2
 $\text{Res}(f, a)$ Residue 7.1
 $\text{sign}(A)$ Signature 5.18
 $SL_2(\mathbb{R})$ 9.11
 $Z(f)$; Zero set of f ; 6.3

INDEX

A

accumulation point 5.3
algebra, fundamental theorem of 4.16
analytic function 4.8
annulus 6.14
arccos function 5.5
arcsin function 5.16
arctan function 3.14, 5.5
argument i.1, 5.5
argument function 5.5
argument, principle of 7.4
argument, variation of 5.8
automorphism group $\text{Aut}(G)$ 8.4

B

Bernoulli numbers 6.25, 6.26, 7.22
Bessel functions 6.25
biholomorphic 5.15
binomial series 5.14
Binet's formula 6.26
Borel's covering theorem 4.11
branch point 5.9

C

C^1 -curve 2.3
Casorati-Weierstrass' theorem 6.7
Cauchy-Riemann's differential equations 1.6
Cauchy's integral theorem 3.3, 3.6
Cauchy's integral formula 3.9
Cauchy's integral formula for derivatives 4.7
Cauchy multiplication 5.25
Cauchy's residue theorem 7.1
Cayley transformation 9.9
chordal metric 9.1
cluster point 5.3
complex differentiable 1.1
complex number i.1
component 5.20, 5.23
conformal 1.5
conformal mapping 1.5
conjugate harmonic function 4.10
connected component 5.20, 5.23
continuous curve 2.2
contour 2.6
contour integral 2.3
contraction 9.4
convex 3.2
cosine function 1.15

cotangent function 1.18
countable 5.3, A.4
curve
- closed 2.2
- continuous 2.2
- Jordan 2.3
- oriented continuous 2.2
- reverse 2.3
- simple 2.3
- smooth 2.3

D

decomposition, partial fraction 6.9
derivative 1.1
differentiable, complex 1.1
discrete set 5.3
division of polynomials 4.17
domain 1.8, 5.2
- annular=annulus 6.14
- simply connected 3.1
- star-shaped 3.1

E

elliptic function 5.17
elliptic integral 5.17
entire function 4.15
estimation lemma 2.6
Euler's formulas 1.15
Euler's partial fraction decomposition 7.18
exponential function 1.13
extended complex plane 9.1

F

Fibonacci-numbers 6.26
Fresnel's integrals 3.15
fundamental theorem of algebra 4.16

G

generalized circle 9.7
Goursat's lemma 3.3

H

harmonic function 4.9
holomorphic function 1.1
holomorphic branch 5.9, 5.12, 5.14
homeomorphism 9.4
homothetic transformation 9.4
homotopy 3.1
hyperbolic functions 1.18

I

identity theorem
 - for holomorphic fcts. 6.4
 - for power series 1.12
 imaginary part i.1
 indeterminate moment problem 7.22
 integral along C^1 -curve 2.3
 integral along a path 2.6
 inversion 9.5
 isolated point 5.3
 isolated singularity 6.5

J

Jacobian 1.8
 Jordan curve 2.3
 Jordan's theorem 2.3

L

Laplace operator 4.9
 Laurent series 6.13
 Leibniz' formula 1.22
 length of path 2.6
 l'Hospitals rule 6.4
 linear fractional transformation 9.4
 Liouville's theorem 4.16
 local uniform convergence 4.11

M

maximum modulus principle
 - global version 8.2
 - local version 8.1
 meromorphic function 6.11
 modulus i.1
 Morera's theorem 4.11
 Möbius transformation 9.4

N

numerical value i.1

O

open mapping theorem 7.7
 order
 - pole 6.6
 - zero 6.2

P

parameterization 2.2
 partial fraction decomposition 6.9
 path 2.6
 path connected 5.1
 path integral 2.3

paving lemma 5.2
 Picard's theorem 4.16
 Picard's great theorem 6.7
 pointwise convergence 4.1
 polar coordinates i.1
 pole 6.6
 polynomials 4.16
 powers 5.13
 primitive 2.7
 principal argument 5.5
 principal logarithm 5.11, exc. 3.6
 principal part 6.7, 6.19

R

radius of convergence 1.9
 rational function 6.8
 real part i.1
 reflection principle 6.23
 residue 7.1
 Riemann's mapping theorem 5.15
 Riemann sphere 9.1
 Riemann surface 5.1, 5.10
 Riemann's ζ -function 4.23
 Rouché's theorem 7.6
 rotation angle 1.6

S

Schwarz' lemma 8.3
 sequence of functions 4.1
 - local uniform convergence 4.11
 - pointwise convergence 4.1
 - uniform convergence 4.2
 signature 5.18
 similitude 9.4
 simple pole 6.6
 simple zero 6.2
 simply connected 3.1
 sine function 1.15
 singularity
 - essential 6.6
 - isolated 6.5
 - removable 6.5
 speed 2.3
 staircase line 1.8
 star-shaped 3.1
 stereographic projection 9.3
 stretching 9.4

T

tangent function 1.18
 Taylor series 4.6

transcendental entire function 6.20
translation 9.4
trigonometric functions 1.15

U

uncountable A.4
uniform convergence 4.2

W

Weierstrass' M-test 4.4
winding number 5.8, 5.20

Z

zero 6.1

